

Floating Ball Valve

Side entry floating ball valve summary

The floating ball valve is simple structure type. It has two seat supporting the ball, the ball can tightly move towards the sealing to easure seal at outlet end.

Standard design

API 608, ISO 17292 design and construction
ASME B16.5, B16.25 ends connection
Anti-blowout stem
Fire-safe, anti-static
Floating ball type
Fire safe acc to ISO 10497, API 607, API 6FA, BS 6755-2

Optional design

Connection end as required
Unidirectional seal type
Extended stem
Extended bonnet
Metal to metal seat
On-site maintenance pocket overlay
Seat or stem seal area overlay
Wetted parts overlay

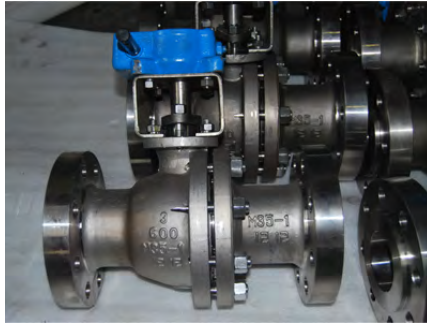
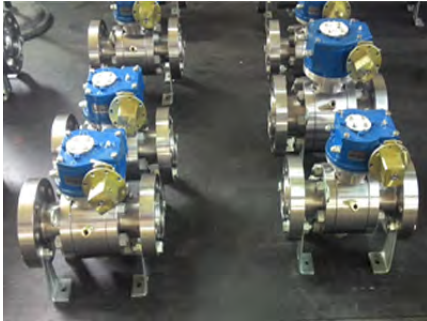

Trunnion Mounted Ball Valve

Standard design

API 6D, API 608, ISO 17292 ASME VIII design and construction
ASME B16.5, B16.25 connection end
Anti-blowout stem
Fire-safe, anti-static
Trunnion mounted ball type (pivot)
DBB structure
Self-Relieving Seat Effect
Fire safe acc to ISO 10497, API 607, API 6FA, BS 6755-2

Optional design

Connection end as required
Double piston effect seat
One side single piston effect seat and other side double piston effect seat
Sealant injection at seat and stem
Extended stem
Extended bonnet
Metal to metal seat
On-site maintenance Pocket overlay
Seat or stem seal area overlay
Wetted parts overlay



Fully Welded Ball Valve

Standard design

API 6D, ISO 17292, B16.34, ASME VIII design and construction
ASME B16.5, B16.25 connection end
Anti-blowout stem
Fire-safe, anti-static
DBB structure
Self-Relieving Seat Effect (limited to fixed ball)
Fire safe acc to ISO 10497, API 607, API 6FA, BS 6755-2

Optional design

Connection end as required
Double piston effect seat
One side single piston effect seat and other side double piston effect seat
Sealant injection at seat and stem
Extended stem
Extended bonnet
Metal to metal seat
On-site maintenance pocket overlay
Seat or stem seal area overlay
Wetted parts overlay



Top Entry Ball Valve

General comments for top entry ball valve

The features of top-entry ball valve is one piece type body, so that the valve leaking points are less than normal type valve. The top entry ball valve can maintenance online, and the body can be designed casting or forging.

Standard design

API 6D, ISO 17292, B16.34, ASME VIII design and construction
ASME B16.5, B16.25 connection end
Anti-blowout stem
Fire-safe, anti-static
DBB structure
Self-Relieving Seat Effect (limited to fixed ball)
Fire safe acc to ISO 10497, API 607, API 6FA, BS 6755-2

Optional design

Connection end as required
Double piston effect seat
One side single piston effect seat and other side double piston effect seat
Sealant injection at seat and stem
Extended stem
Extended bonnet
Metal to metal seat
On-site maintenance pocket overlay
Seat or stem seal area overlay
Wetted parts overlay



Metal-to-metal Seat Ball Valve

Metal-to-metal wear-resisting ball valve summary

The valve structure can be designed casting or forging type body, seat is Metal-to-metal type, and have floating ball and trunnion mounted ball form. Overlay on ball and seat seal area are made with HVOF.

The HVOF process is use of combustible gas and oxygen combustion in special chamber, and then generating high temperature and speed flame, the speed about 1500~2000m/s, by an inert gas the powder is sent into the combustion chamber, and the powder will be melted down or half melted and its speed will be increased to 300~500m/s or higher, so that the coating layer will be high strength, compact and better quality.

The HVOF is use of a DC arc between cathode and anode, the arc heat and ionize work gas into high temperature plasma, and spray out plasma flame form nozzle. When powder is sent into plasma flame, it will be melted down, accelerated and sprayed on pretreatment base material, and formed into coating.



Metal-to-metal Seat Ball Valve

Standard design

API 6D, API 608, ISO 17292, ASME VIII design and construction
ASME B16.5, B16.25 connection end
Anti-blowout stem
Fire-safe, anti-static
Floating ball type
Trunnion mounted ball type
DBB structure
Self-Relieving Seat Effect (only for trunnion mounted)
Fire-safe acc to ISO 10497, API 607, API 6FA, BS 6755-2

Optional design

Connection end as required
Single piston effect seat
One side single piston effect seat and other side double piston effect seat
Extended stem
Extended bonnet
Metal to metal seat
On-site maintenance pocket overlay
Seat or stem seal area overlay
Wetted parts overlay



Cryogenic Ball Valve

Cryogenic service ball valve summary

The valve structure can be designed casting or forging type, seat seal type have soft-seal and metal-to-metal seal, and have floating ball and trunnion mounted ball form.

To prevent abnormal rising pressure in the valve body cavity, at upstream side the ball will be made a hole to connect body cavity between upstream pipeline and balance pressure. So at installing need to consider the medium flow direction. The valve seat structure is used DBB type, that can self-relieving pressure into upstream or downstream pipeline when the body cavity pressure abnormal rising.

Between body and seat the seal type is designed double Lip-seal or with reversed-load double Lip-seal. Between stem and packing is used Lip-seal + graphite type. The valve packing will be loaded Belleville spring in order to prevent looseness.

The valve bonnet is designed extended-bonnet type acc. To different service temperature in order to keep packing seat temperature above 0°C. The length of extended section acc to MESC SPE 77/200, the specific dimension as shown in the following table.

mm(inch)

Min design temperature		Extended Bonnet Neck Height								
		15 (1/2)	40 (1 1/2)	80 (3)	150 (6)	250 (10)	350 (14)	450 (18)	700 (28)	900 (36)
Min °C (°F)	Max °C (°F)	25 (1)	50 (2)	100 (4)	200 (8)	300 (12)	400 (16)	600 (24)	800 (32)	1200 (48)
-196 (-321)	-110 (-166)	200 (7.9)	250 (9.8)	300 (11.8)	350 (13.8)	400 (15.8)	450 (17.7)	500 (19.7)	550 (21.7)	600 (23.6)
-109 (-165)	-50 (-58)	100 (3.9)	125 (4.9)	150 (5.9)	175 (6.9)	200 (7.9)	250 (9.8)	300 (11.8)	350 (13.8)	400 (15.8)
-49 (-57)	-30 (-22)	100 (3.9)	125 (4.9)	150 (5.9)	175 (6.9)	200 (7.9)	225 (8.9)	250 (8.9)	275 (10.8)	300 (11.8)



Cryogenic Ball Valve

Standard design

API 6D, BS6364, MESC SPE 77/200, ASME VIII design and construction
ASME B16.5, B16.25 connection end
Anti-blowout stem
Fire-safe, anti-static
Floating ball type
Trunnion mounted ball type
DBB structure
Self-Relieving Seat Effect (only for trunnion mounted)
Fire-safe acc to ISO 10497, API 607, API 6FA, BS 6755-2

Optional design

Connection end as required
Single piston effect seat
One side single piston effect seat and other side double piston effect seat
≥-46°C, seat material is made of ptfе; at -46°C~196°C, seat material is made of pctfe.
Lip-seal design type
Extended stem
Extended bonnet
Metal to metal seat
On-site maintenance pocket overlay
Seat or stem seal area overlay
Wetted parts overlay



Production Series

Side entry floating ball valve

Service range	ASME Class150	ASME Class300	ASME Class600	ASME Class900	ASME Class1500	ASME Class2500
Normal temperature ball valve	1/2" ~12"	1/2" ~10"	1/2" ~4"	1/2" ~3"	1/2" ~3"	1/2" ~2"
Cryogenic ball valves (-196 °C)	1/2" ~8"	1/2" ~8"	1/2" ~4"	1/2" ~3"	1/2" ~3"	1/2" ~2"
Subsea ball valve	2" ~12"	1/2" ~10"	1/2" ~4"	1/2" ~3"	1/2" ~3"	1/2" ~2"
Under ground installation of ball valve	2" ~12"	1/2" ~10"	1/2" ~4"	1/2" ~3"	1/2" ~3"	1/2" ~2"
High temp ball valve +220 °C to +750 °C)	1/2" ~12"	1/2" ~10"	1/2" ~4"	1/2" ~3"	1/2" ~3"	1/2" ~2"

Side entry trunnion mounted ball valve

Service range	ASME Class150~600	ASME Class900	ASME Class1500	ASME Class2500
Normal temperature ball valve	1" ~64"	1" ~56"	1" ~40"	1" ~32"
Cryogenic ball valves (-196 °C)	1" ~36"	1" ~36"	1" ~24"	1" ~12"
Subsea ball valve	1" ~64"	1" ~56"	1" ~40"	1" ~32"
Under ground installation of ball valve	1" ~64"	1" ~56"	1" ~40"	1" ~32"
High temp ball valve +220 °C to +750 °C)	1" ~36"	1" ~36"	1" ~24"	1" ~12"

Top entry Floating ball valve

Service range	ASME Class150	ASME Class300	ASME Class600
Normal temperature ball valve	1/2" ~2"	1/2" ~2"	1/2" ~2"
Cryogenic ball valves (-196 °C)	1/2" ~2"	1/2" ~2"	1/2" ~2"
Subsea ball valve	1/2" ~2"	1/2" ~2"	1/2" ~2"
Under ground installation of ball valve	1/2" ~2"	1/2" ~2"	1/2" ~2"
High temp ball valve +220 °C to +750 °C)	1/2" ~2"	1/2" ~2"	1/2" ~2"

Production Series

Top entry trunnion mounted ball valve

Service range	ASME Class150~600	ASME Class900	ASME Class1500	ASME Class2500
Normal temperature ball valve	2" ~56"	2" ~48"	2" ~30"	2" ~16"
Cryogenic ball valves (-196 °C)	2" ~36"	2" ~36"	2" ~24"	2" ~12"
Subsea ball valve	2" ~56"	2" ~48"	2" ~30"	2" ~16"
Under ground installation of ball valve	2" ~56"	2" ~48"	2" ~30"	2" ~16"
High temp ball valve +220 °C to +750 °C)	2" ~36"	2" ~36"	2" ~24"	2" ~12"

Fully welded floating ball valve

Service range	ASME Class150~600	ASME Class900	ASME Class1500	ASME Class2500
Normal temperature ball valve	1/2" ~4"	1/2" ~3"	1/2" ~3"	1/2" ~2"
Cryogenic ball valves (-196 °C)	1/2" ~4"	1/2" ~3"	1/2" ~3"	1/2" ~2"
Subsea ball valve	1/2" ~4"	1/2" ~3"	1/2" ~3"	1/2" ~2"
Under ground installation of ball valve	1/2" ~4"	1/2" ~3"	1/2" ~3"	1/2" ~2"
High temp ball valve +220 °C to +750 °C)	1/2" ~4"	1/2" ~3"	1/2" ~3"	1/2" ~2"

Fully welded trunnion ball valve

Service range	ASME Class150~600	ASME Class900	ASME Class1500	ASME Class2500
Normal temperature ball valve	2" ~64"	2" ~56"	2" ~36"	2" ~20"
Cryogenic ball valves (-196 °C)	2" ~36"	2" ~36"	2" ~36"	2" ~20"
Subsea ball valve	2" ~64"	2" ~56"	2" ~36"	2" ~20"
Under ground installation of ball valve	2" ~64"	2" ~56"	2" ~36"	2" ~20"

Design Features

Design features	Side entry ball valve	Top entry ball valve	Fully welded ball valve
API 6D or API 608 Design and Construction	Standard	Standard	Standard
Face-To-Face dimensions to API 6D or ASME B16.10	Standard	Standard	Standard
Floating Ball	Standard	Standard	Standard
Unidirectional seal structure	Standard	Standard	Standard
Trunnion Mounted Ball	Standard	Standard	Standard
Independent stem and Ball	Standard	Standard	Standard
Floating seats	Standard	Standard	Standard
Soft seated	Optional	Optional	Optional
Metal-To-Metal seated	Optional	Optional	Optional
Delta-ring seal seat	Optional	Optional	Optional
Primary Metal-secondary soft seats	Optional	Optional	Optional
O-ring seal structure	Standard	Standard	Standard
Lip-seal type	Optional	Optional	Optional
Cavity relieving seats	Standard	Standard	Standard
Single piston effect seats (DBB type)	Optional	Optional	Optional
Double piston effect seats (DIB-1 type)	Optional	Optional	Optional
One side single piston effect seats and other side Double piston effect seat (DIB-2 type)	Optional	Optional	Optional
ENP ball (Soft seated structure)	Standard	Standard	Standard
Full bore or reduced bore	As requested	As requested	As requested
Flanged Ends / Welded Ends / Thread Ends	As requested	As requested	As requested
Adaptor pups for welded ends valves	Optional	Optional	Optional
Fire safety structure	Standard	Standard	Standard
Anti-static device	Standard	Standard	Standard
Anti-blowout stem	Standard	Standard	Standard
Shell test pressure shall be 1.5PN	Standard	Standard	Standard
MAST Maxi Allowed stew Torque 3 times than Torque	Standard	Standard	Standard
sealant injection fitting structure lubricant injector	Optional	Optional	Optional
Cavity pressure relief type	Optional	Optional	Optional
Drain plug	Standard	Standard	Standard
Stem injection fitting	Optional	Optional	Optional
Seat injection fitting	Optional	Optional	Optional
Seat surface overlay	Optional	Optional	Optional
Seal pocket place overlay	Optional	Optional	Optional
wetted parts overlay	Optional	Optional	Optional
Body internal lining	Optional	Optional	N/A
Extended stem for underground installation	Optional	Optional	Optional
Extended stem for low or high temperature valve	Optional	Optional	Optional
Lock device	Optional	Optional	Optional
Lifting lugs / standing lug	Standard	Standard	Standard
Manual or actuated operation device	As requested	As requested	As requested
On-line maintenance	Yes	Yes	No
On-site maintenance	Yes	Yes	Yes (For stem seals noly)

Design Features

Double Block & Bleed Valve(DBB)

The valve cavity is isolated by double seats. Even when there is pressure inside the pipeline, pressure can be discharged safely. This kind of operation can serve as a means to detect leakage in the pipeline. When the valve is fully opened or fully closed, the blowdown valve or pressure relief valve can be used to detect if there is any leakage at the seat.

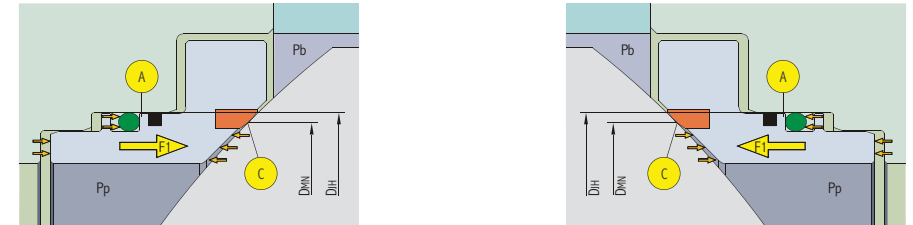

Double Isolation & Block Valve (DIB-1)

The seats at both ends have the double-piston effect. When the valve is closed, if leakage takes place in the upstream seat, the medium will enter the cavity, the downstream seat will stop the medium entering the downstream pipeline, and vice versa.

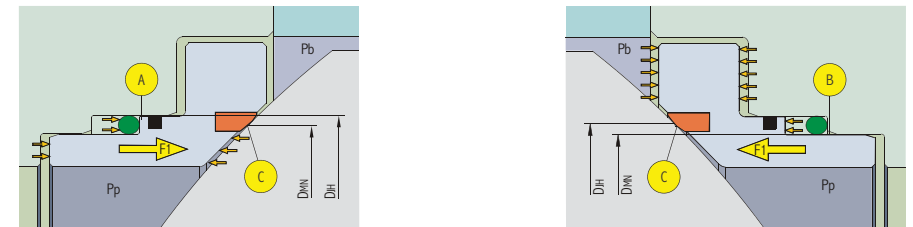

Double Isolation & Block Valve (DIB-2)

The seat at one end has the single-piston effect and the seat at the other end has the double-piston effect. For instance, if the valve is assembled with the single-piston effect seat at the upstream side and the double-piston effect seat at the downstream side, when the valve cavity pressure rises to be 1.33 times the valve pressure rating, the medium inside the cavity will be automatically discharged to the upstream side, so that the safety of valve cavity is ensured. Attention should be paid to the direction when the valve of this kind of structure is installed.

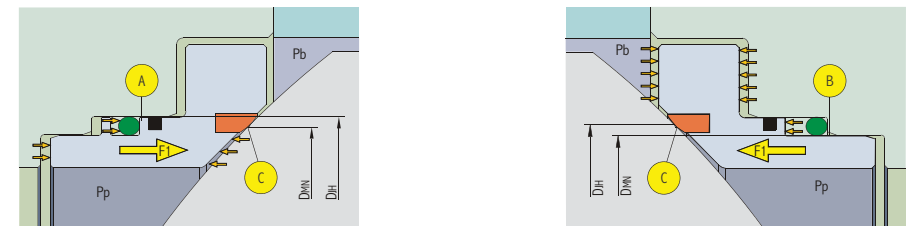

Design Features

Self Relief Seat

The self relief seat can avoid abnormal rise of valve cavity pressure. when the valve cavity pressure rise to 1.1 ~ 1.33 times the rated pressure, seat start automatic pressure release. It can also be interpreted as a single-piston effect seat.

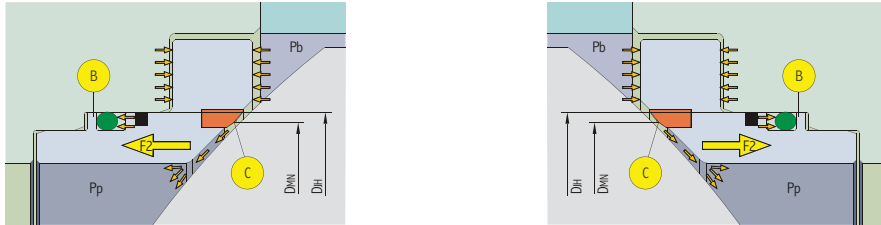

Structure of valve seat

► Metal to Metal Seat

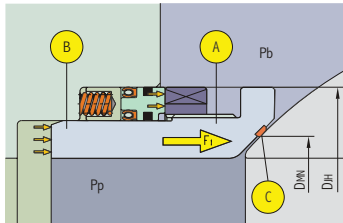

Temperature Range: -196°C ~ +120°C

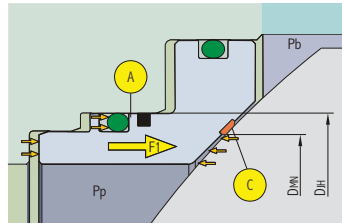

Temperature Range: -46°C ~ +120°C

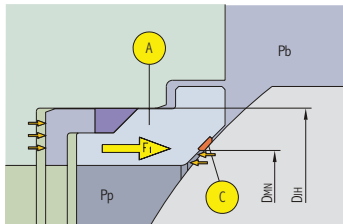

Temperature Range: -29°C ~ +538°C

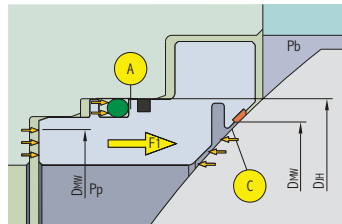

Temperature Range: -46°C ~ +220°C

Design Features

Emergency Sealant Injection

Upon request our valves can be equipped with emergency sealant injection at stem and seat position for this feature, the sealant injection will provide a simple method to restore valve tightness in case of damaged sealing materials in the stem or seat area. If necessary, the sealant injection can be used for regular cleaning seat seal area.

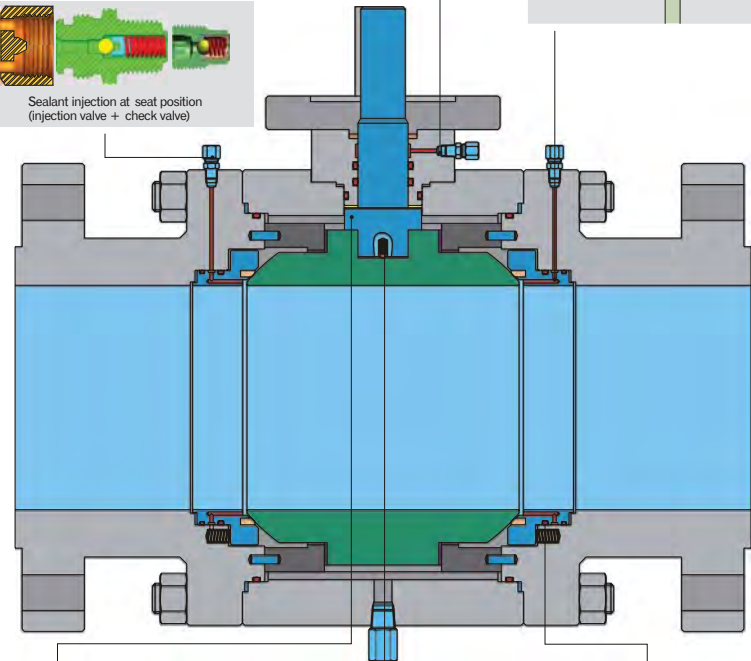
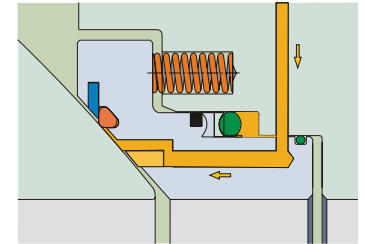
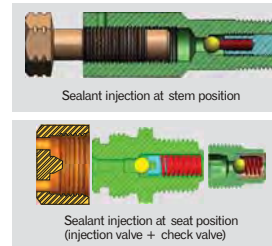

Anti-Blowout Design

For the sake of safety, the stem must be designed with a blow-out proof device to prevent the stem from being blown out by the internal pressure when the packing gland or actuator yoke is removed.

Anti-static Device

In order to avoid accidents arising from static accumulation, all metal ball valves are provided with an anti-static device at the body, the ball and the stem, so that the static electricity produced by the valve itself can be smoothly discharged out of the valve. The anti-static device is composed of the metal ball and the spring.

Fire Safe Design

The valve is designed to have double-sealing. The first seal is the soft seal and the second seal is the metal seal. In case of fire, the soft seal is burnt and the metal seal will play its role in reducing medium leakage. The fire resistance design of valves is qualified by fire testing in accordance with API 607, API 6FA and ISO 10497, and meets the fire-safe requirements in API 607 and API 6FA.

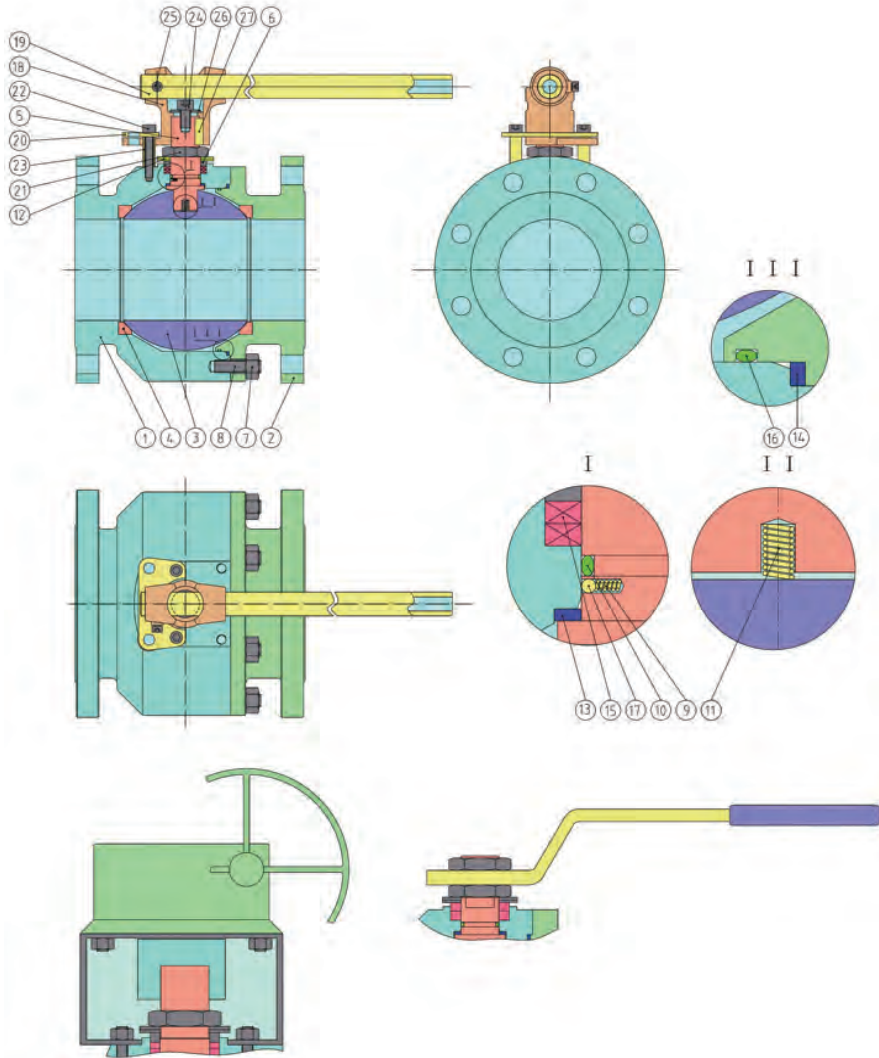

No	Part	Standard	Stainless Steel	Sour Service	Low Temperature
1	Body	ASTM A105	ASTM A182 F316	ASTM A105	ASTM A350 LF2
2	Bonnet	ASTM A105	ASTM A182 F316	ASTM A105	ASTM A350 LF2
3	Ball	ASTM A182 F316	ASTM A182 F316	ASTM A182 F316	ASTM A182 F316
4	Seat	PTFE(TFM1700)	PTFE(TFM1700)	PTFE(TFM1700)	PTFE(TFM1700)
5	Stem	ASTM A182 F316	ASTM A182 F316	ASTM A182 F316	ASTM A182 F316
6	Compression Ring	SS316	SS316	SS316	SS316
7	Stud	ASTM A193 B7	ASTM A193 B8	ASTM A193 B7M	ASTM A320 L7M
8	Nut	ASTM A194 2H	ASTM A194 8	ASTMA194 2HM	ASTM A194 7M
9	Anti-static Ball	Stainless Steel	Stainless Steel	Stainless Steel	Stainless Steel
10	Anti-static Spring	Stainless Steel	Stainless Steel	Stainless Steel	Stainless Steel
11	Anti-static Spring	Stainless Steel	Stainless Steel	Stainless Steel	Stainless Steel
12	Disc Spring	17-7PH	17-7PH	17-7PH	17-7PH
13	THrust Gasket	PTFE	PTFE	PTFE	PTFE
14	Wound Gasket	SS316+Graphite	SS316+Graphite	SS316+Graphite	SS316+Graphite
15	Packing	Flexible Graphite	Flexible Graphite	Flexible Graphite	Flexible Graphite
16	O-ring	Viton	Viton	Viton	HNBR
17	O-ring	Viton	Viton	Viton	HNBR
18	Handle Cover	Galvanized Carbon Steel	Galvanized Carbon Steel	Galvanized Carbon Steel	Galvanized Carbon Steel
19	Steel Pipe	Galvanized Carbon Steel	Galvanized Carbon Steel	Galvanized Carbon Steel	Galvanized Carbon Steel
20	LOCK Plate	Galvanized Carbon Steel	Galvanized Carbon Steel	Galvanized Carbon Steel	Galvanized Carbon Steel
21	Stem Nut	ASTM A193 B7	ASTM A193 B8	ASTM A193 B7M	ASTM A320 L7M
22	Screw	ASTM A193 B8	ASTM A193 B8	ASTM A194 2HM	ASTM A320 L7M
23	Steel Pipe	Stainless Steel	Stainless Steel	Stainless Steel	Stainless Steel
24	Screw	ASTM A193 B7	ASTM A193 B8	ASTM A193 B7M	ASTM A320 L7M
25	Screw	ASTM A194 2H	ASTM A194 8	ASTM A194 2HM	ASTM A194 7M
26	Washer	Galvanized Carbon Steel	Galvanized Carbon Steel	Galvanized Carbon Steel	Galvanized Carbon Steel
27	Key	Carbon Stee	Carbon Stee	Carbon Stee	Carbon Stee

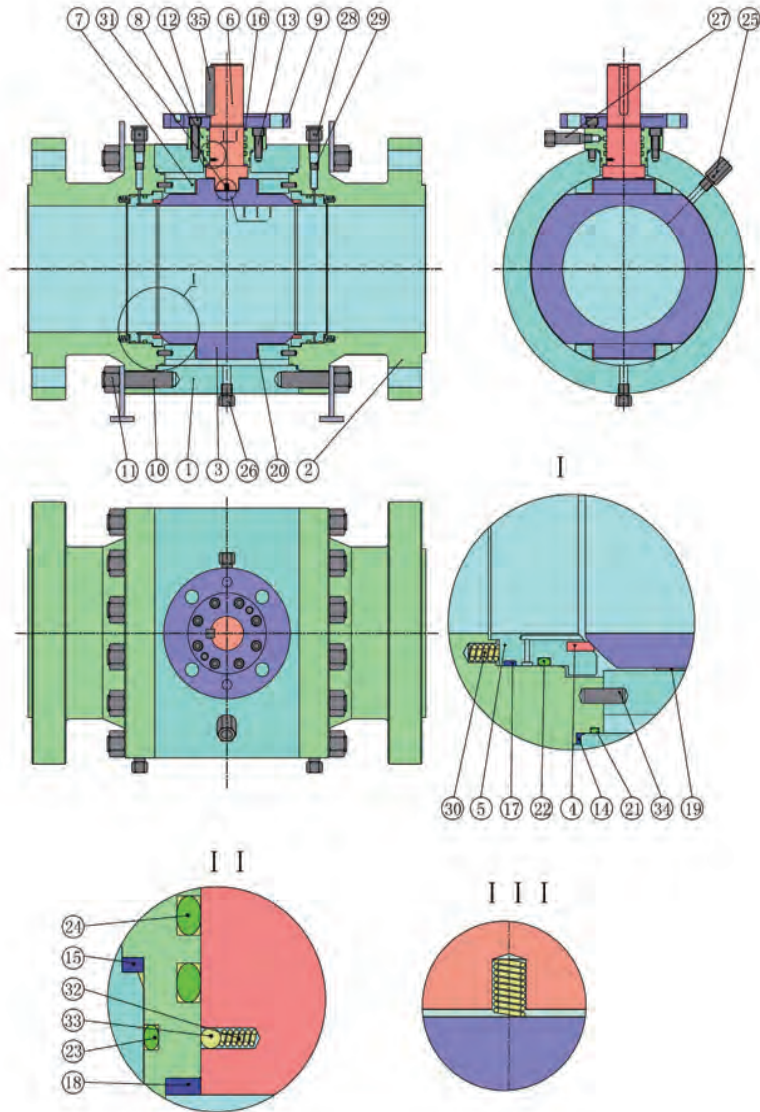

No	Part	Standard	Stainless Steel	Sour Service	Low Temperature
1	Body	ASTM A105	ASTM A182 F316	ASTM A105	ASTM A350 LF2
2	Bonnet	ASTM A105	ASTM A182 F316	ASTM A105	ASTM A350 LF2
3	Ball	ASTM A105+ENP	ASTM A182 F316	ASTM A105+ENP	ASTM A350 LF2+ENP
4	Soft Seat	PTFE(TFM1700)	PTFE(TFM1700)	PTFE(TFM1700)	PTFE(TFM1700)
5	Seat	ASTM A105+ENP	ASTM A182 F316	ASTM A105+ENP	ASTM A350 LF2+ENP
6	Stem	ASTM A105+ENP	ASTM A182 F316	ASTM A105+ENP	ASTM A350 LF2+ENP
7	Support Plate	ASTM A105+ENP	ASTM A182 F316	ASTM A105+ENP	ASTM A350 LF2+ENP
8	Packing Gland	ASTM A105+ENP	ASTM A182 F316	ASTM A105+ENP	ASTM A350 LF2+ENP
9	Top Flange	ASTM A105	ASTMA182 F316	ASTM A105	ASTM A350 LF2
10	Stud	ASTM A193 B7	ASTM A193 B8M	ASTMA193 B7M	ASTM A350 L7M
11	Nut	ASTM A194 2H	ASTM A194 8M	ASTM A194 2HM	ASTM A194 7M
12	Screw	ASTM A193 B7	ASTMA193 B8M	ASTMA193 B7M	ASTM A350 L7M
13	Pin	Carbon Stee	Stainless Stee	Carbon Stee	Stainless Stee
14	Wound Gasket	SS316+Graphite	SS316+Graphite	SS316+Graphite	SS316+Graphite
15	Wound Gasket	SS316+Graphite	SS316+Graphite	SS316+Graphite	SS316+Graphite
16	Packing	Flexible Graphite	Flexible Graphite	Flexible Graphite	Flexible Graphite
17	Packing	Carbon Fiber+Graphite	Carbon Fiber+Graphite	Carbon Fiber+Graphite	Carbon Fiber+Graphite
18	Wound Gasket	PTFE/SS316+PTFE	PTFE/SS316+PTFE	PTFE/SS316+PTFE	PTFE/SS316+PTFE
19	Gasket	PTFE	PTFE	PTFE	PTFE
20	Bearing	SS316+PTFE+MOS2	SS316+PTFE+MOS2	SS316+PTFE+MOS2	SS316+PTFE+MOS2
21	O-ring	Viton	Viton	Viton	HNBR
22	O-ring	Viton	Viton	Viton	HNBR
23	O-ring	Viton	Viton	Viton	HNBR
24	O-ring	Viton	Viton	Viton	HNBR
25	Vent Valve	Stainless Steel	Stainless Steel	Stainless Steel	Stainless Steel
26	Blind Plug	Stainless Steel	Stainless Steel	Stainless Steel	Stainless Steel
27	Lnjection Valve	Stainless Steel	Stainless Steel	Stainless Steel	Stainless Steel
28	Lnjection Valve	Stainless Steel	Stainless Steel	Stainless Steel	Stainless Steel
29	Check Valve	Stainless Steel	Stainless Steel	Stainless Steel	Stainless Steel
30	Seat Spring	Incone x-750	Incone x-750	Incone x-750	Incone x-750
31	Anti-static Spring	Stainless Steel	Stainless Steel	Stainless Steel	Stainless Steel
32	Anti-static Spring	Stainless Steel	Stainless Steel	Stainless Steel	Stainless Steel
33	Anti-static Ball	Stainless Steel	Stainless Steel	Stainless Steel	Stainless Steel
34	Pin	Carbon Stee	Stainless Steel	Carbon Stee	Stainless Steel
35	Key	Carbon Stee	Stainless Steel	Carbon Stee	Stainless Steel

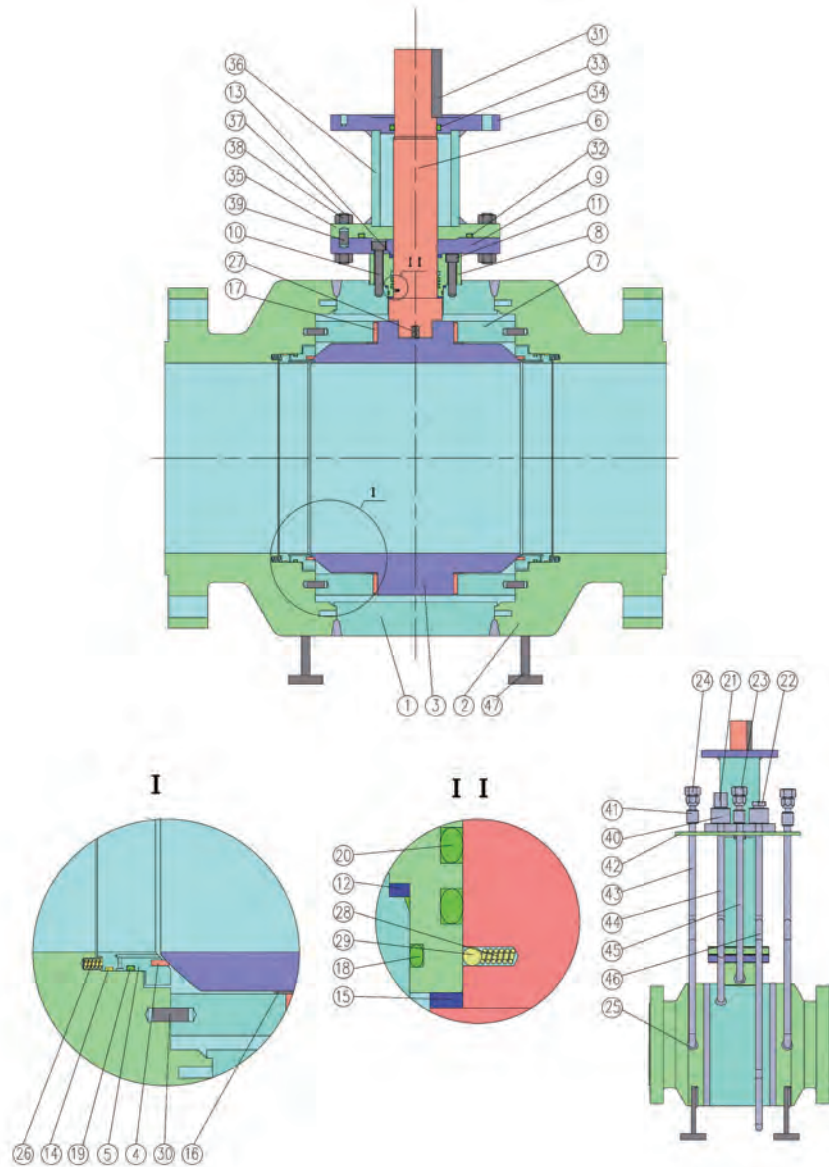

No	Part	Standard	Stainless Steel	Sour Service	Low Temperature
1	Body	ASTM A105	ASTM A182 F316	ASTM A105	ASTM A350 LF2
2	Bonnet	ASTM A105	ASTM A182 F316	ASTM A105	ASTM A350 LF2
3	Ball	ASTM A105+ENP	ASTM A182 F316	ASTM A105+ENP	ASTM A350 LF2+ENP
4	Soft Seat	PTFE(TFM1700)	PTFE(TFM1700)	PTFE(TFM1700)	PTFE(TFM1700)
5	Seat	ASTM A105+ENP	ASTM A182 F316	ASTM A105+ENP	ASTM A350 LF2+ENP
6	Stem	ASTM A105+ENP	ASTM A182 F316	ASTM A105+ENP	ASTM A350 LF2+ENP
7	Support Plate	ASTM A105+ENP	ASTM A182 F316	ASTM A105+ENP	ASTM A350 LF2+ENP
8	Packing Gland	ASTM A105+ENP	ASTM A182 F316	ASTM A105+ENP	ASTM A350 LF2+ENP
9	Top Fland	ASTM A105	ASTM A182 F316	ASTM A105	ASTM A350 LF2
10	Screw	ASTM A193 B7	ASTM A193 B8	ASTM A193 B7M	ASTM A350 L7M
11	Pin	Carbon Stee	Stainless Stee	Carbon Stee	Stainless Stee
12	Wound Gasket	SS316+Graphite	SS316+Graphite	SS316+Graphite	SS316+Graphite
13	Packing	Flexible Graphite	Flexible Graphite	Flexible Graphite	Flexible Graphite
14	Packing	Carbon Fiber+Graphite	Carbon Fiber+Graphite	Carbon Fiber+Graphite	Carbon Fiber+Graphite
15	Thrust Gasket	PTFE/SS316+PTFE	PTFE/SS316+PTFE	PTFE/SS316+PTFE	PTFE/SS316+PTFE
16	Gasket	PTFE	PTFE	PTFE	PTFE
17	Bearing	SS316+PTFE+MOS2	SS316+PTFE+MOS2	SS316+PTFE+MOS2	SS316+PTFE+MOS2
18	O-ring	Viton	Viton	Viton	HNBR
19	O-ring	Viton	Viton	Viton	HNBR
20	O-ring	Viton	Viton	Viton	HNBR
21	Vent Valve	Stainless Steel	Stainless Steel	Stainless Steel	Stainless Steel
22	Blind Plug	Stainless Steel	Stainless Steel	Stainless Steel	Stainless Steel
23	Injection Valve	Stainless Steel	Stainless Steel	Stainless Steel	Stainless Steel
24	Injection Valve	Stainless Steel	Stainless Steel	Stainless Steel	Stainless Steel
25	Check Valve	Stainless Steel	Stainless Steel	Stainless Steel	Stainless Steel
26	Seat Spring	Incone x-750	Incone x-750	Incone x-750	Incone x-750
27	Anti-static Spring	Stainless Steel	Stainless Steel	Stainless Steel	Stainless Steel
28	Anti-static Spring	Stainless Steel	Stainless Steel	Stainless Steel	Stainless Steel
29	Anti-static Ball	Stainless Steel	Stainless Steel	Stainless Steel	Stainless Steel
30	Pin	Carbon Stee	Stainless Steel	Carbon Stee	Stainless Steel
31	Key	Carbon Stee	Stainless Steel	Carbon Stee	Stainless Steel
32	O-ring	Viton	Viton	Viton	Viton
33	O-ring	Viton	Viton	Viton	Viton
34	Top Fland	ASTM A105	ASTM A182 F316	ASTM A105	ASTM A350 LF2
35	Fland	ASTM A105	ASTM A182 F316	ASTM A105	ASTM A350 LF2
36	Yoke	Carbon Stee	Stainless Steel	Carbon Stee	Stainless Steel
37	Stud	ASTM A193 B7	ASTM A193 B8M	ASTM A193 B7M	ASTM A350 L7M
38	Nut	ASTM A194 2H	ASTM A194 8M	ASTM A194 2HM	ASTM A194 7M
39	Pin	Carbon Stee	Carbon Stee	Carbon Stee	Carbon Stee
40	Joint	Stainless Steel	Stainless Steel	Stainless Steel	Stainless Steel
41	Joint	Stainless Steel	Stainless Steel	Stainless Steel	Stainless Steel
42	Yoke	Carbon Stee	Carbon Stee	Carbon Stee	Carbon Stee
43	Pipe	Stainless Steel	Stainless Steel	Stainless Steel	Stainless Steel
44	Pipe	Stainless Steel	Stainless Steel	Stainless Steel	Stainless Steel
45	Pipe	Stainless Steel	Stainless Steel	Stainless Steel	Stainless Steel
46	Pipe	Stainless Steel	Stainless Steel	Stainless Steel	Stainless Steel
47	Foot Margin	Carbon Stee	Carbon Stee	Carbon Stee	Carbon Stee

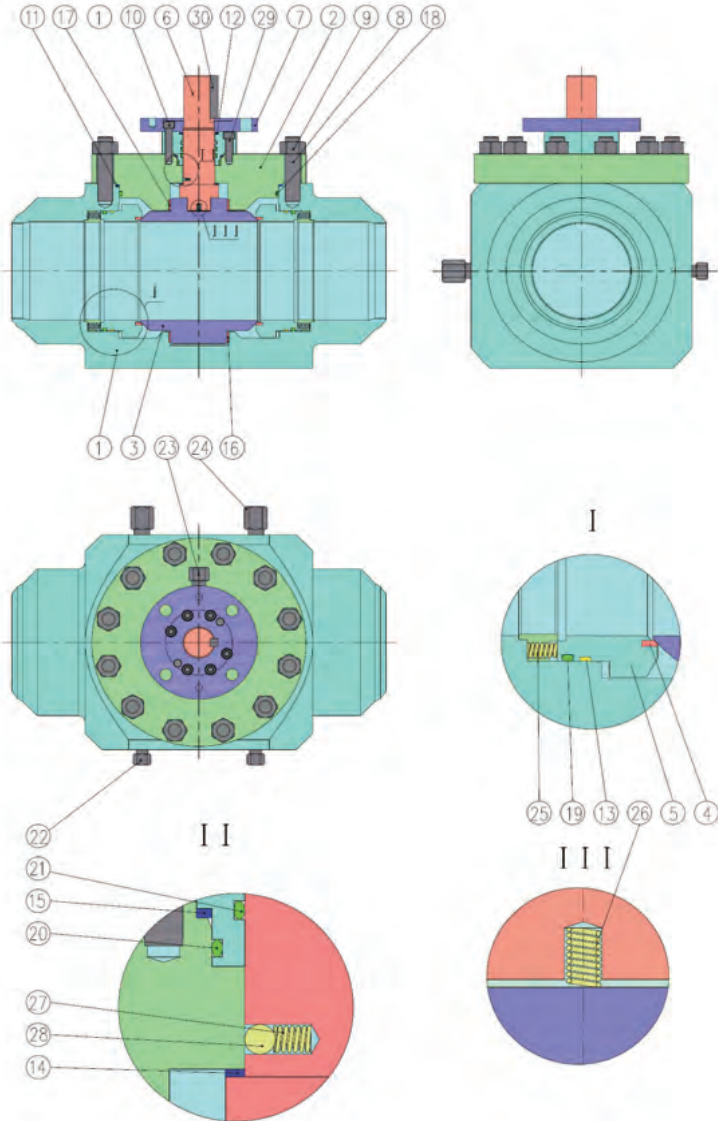

No	Part	Standard	Stainless Steel	Sour Service	Low Temperature
1	Body	ASTM A105	ASTMA182 F316	ASTM A105	ASTM A350 LF2
2	Bonnet	ASTM A105	ASTMA182 F316	ASTM A105	ASTM A350 LF2
3	Ball	ASTM A105+ENP	ASTMA182 F316	ASTM A105+ENP	ASTM A350 LF2+ENP
4	Soft Seat	PTFE(TFM1700)	PTFE(TFM1700)	PTFE(TFM1700)	PTFE(TFM1700)
5	Seat	ASTM A105+ENP	ASTMA182 F316	ASTM A105+ENP	ASTM A350 LF2+ENP
6	Stem	ASTM A105+ENP	ASTMA182 F316	ASTM A105+ENP	ASTM A350 LF2+ENP
7	Top Fland	ASTM A105	ASTMA182 F316	ASTM A105	ASTM A350 LF2
8	Stud	ASTMA193 B7	ASTMA193 B8M	ASTMA193 B7M	ASTM A350 L7M
9	Nut	ASTMA194 2H	ASTMA194 8M	ASTMA194 2HM	ASTMA194 7M
10	Screw	ASTMA193 B7	ASTMA193 B8M	ASTMA193 B7M	ASTM A350 L7M
11	Wound Gasket	SS316+Graphite	SS316+Graphite	SS316+Graphite	SS316+Graphite
12	Wound Gasket	SS316+Graphite	SS316+Graphite	SS316+Graphite	SS316+Graphite
13	Packing	Flexible Graphite	Flexible Graphite	Flexible Graphite	Flexible Graphite
14	Packing	Carbon Fiber+Graphite	Carbon Fiber+Graphite	Carbon Fiber+Graphite	Carbon Fiber+Graphite
15	Wound Gasket	SS316+Graphite	SS316+Graphite	SS316+Graphite	SS316+Graphite
16	Bearing	SS316+PTFE+MOS2	SS316+PTFE+MOS2	SS316+PTFE+MOS2	SS316+PTFE+MOS2
17	Bearing	SS316+PTFE+MOS2	SS316+PTFE+MOS2	SS316+PTFE+MOS2	SS316+PTFE+MOS2
18	O-ring	Viton	Viton	Viton	HNBR
19	O-ring	Viton	Viton	Viton	HNBR
20	O-ring	Viton	Viton	Viton	HNBR
21	O-ring	Viton	Viton	Viton	HNBR
22	Vent Valve	Stainless Steel	Stainless Steel	Stainless Steel	Stainless Steel
23	Injection Valve	Stainless Steel	Stainless Steel	Stainless Steel	Stainless Steel
24	Injection Valve	Stainless Steel	Stainless Steel	Stainless Steel	Stainless Steel
25	Seat Spring	Incone x-750	Incone x-750	Incone x-750	Incone x-750
26	Anti-static Spring	Stainless Steel	Stainless Steel	Stainless Steel	Stainless Steel
27	Anti-static Spring	Stainless Steel	Stainless Steel	Stainless Steel	Stainless Steel
28	Anti-static Ball	Stainless Steel	Stainless Steel	Stainless Steel	Stainless Steel
29	Pin	Carbon Stee	Carbon Stee	Carbon Stee	Carbon Stee
30	Pin	Carbon Stee	Carbon Stee	Carbon Stee	Carbon Stee

Pressure-temperature Rating Figures Of Soft-seal Material

At static pressure

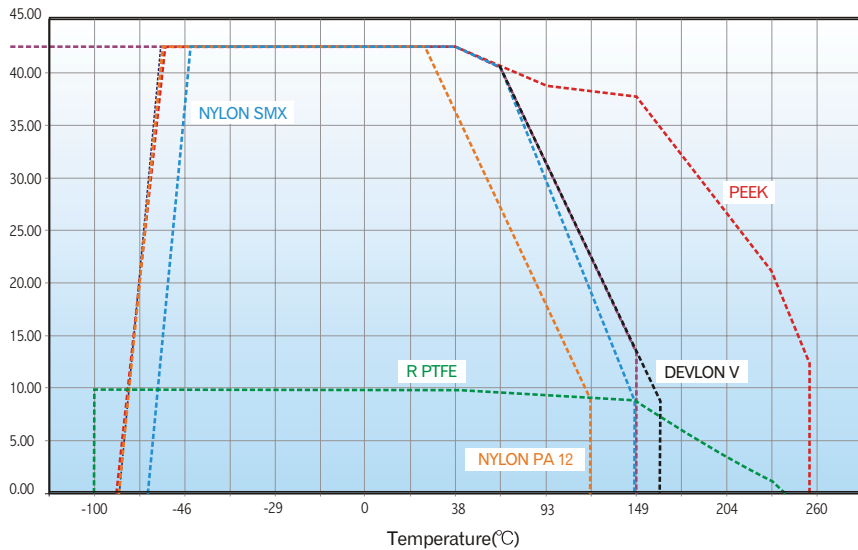
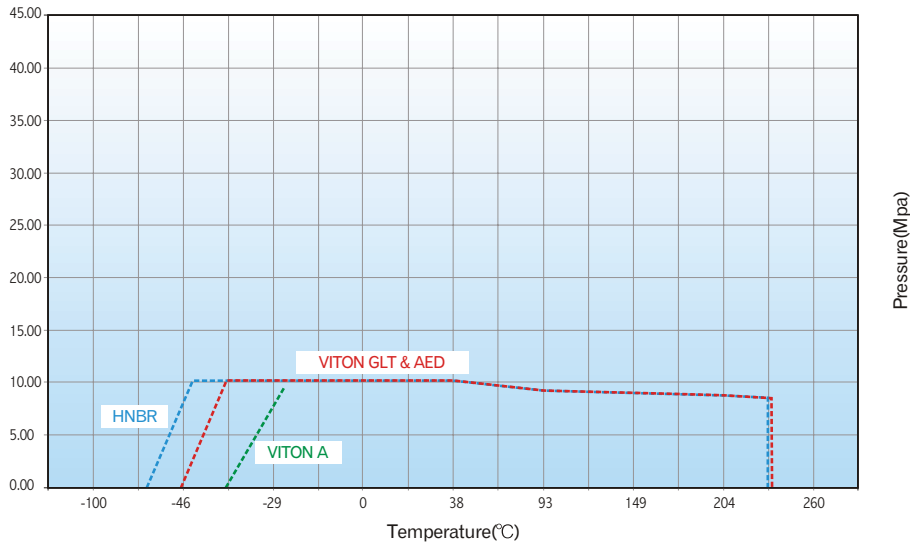

Pressure-temperature Rating Figures Of Soft-seal Material

At operation condition

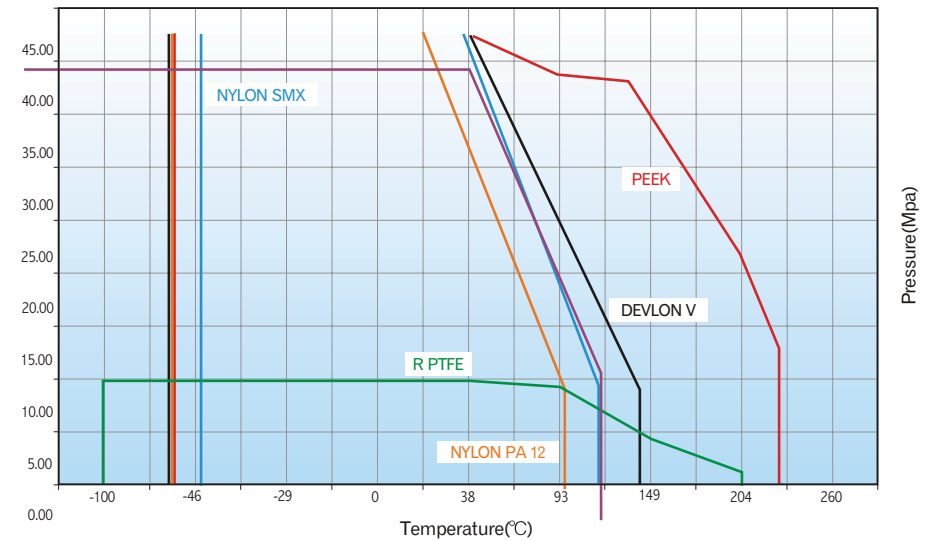
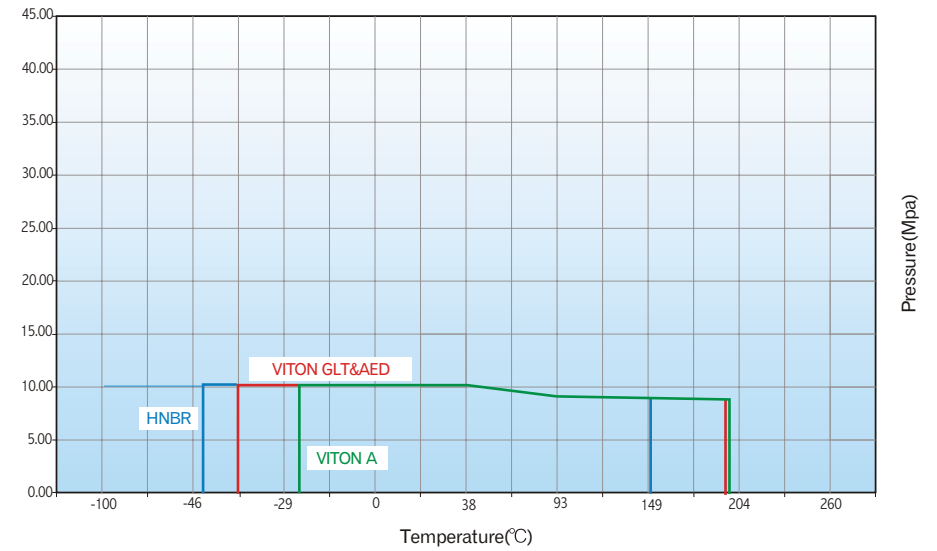

Flow Coefficient

API 6D

NPS (inch)	CLASSES					
	150	300	600	900	1500	2500
2	420	420	400	330	330	250
2 1/2	690	690	610	520	510	320
3×2	200	200	200	190	180	200
3	1200	1050	1000	910	820	500
4×3	600	600	600	590	550	560
4	2200	2100	1850	1800	1400	1100
6×4	800	800	790	790	780	745
6	5150	5100	4600	4380	3800	2500
8×6	2150	2150	2150	2150	2150	2150
8	9500	9400	9000	8500	7400	5300
10×8	4300	4300	4300	4450	4450	4100
10	15000	15000	14700	14500	11500	8300
12×10	7550	7550	7550	8000	9000	7550
14×10	6000	6000	6000	6100	6100	-
12	23000	23000	22500	21100	18000	13000
14×12	14000	14000	14000	12800	13000	-
16×12	9100	9100	9100	8900	8900	-
14	28000	28000	28000	25000	21000	-
16×14	15000	15000	15000	14200	14100	-
16	37200	37200	37200	34500	27500	-
18×16	21000	21000	21000	19200	19000	-
20×16	15300	15300	15300	13800	12000	-
18	49000	49000	49000	45000	37000	-
20×18	28400	28400	28400	25000	25000	-
20	59000	59000	59000	55200	47800	-
24×20	28200	28200	28000	25100	20600	-
22	68200	68200	68200	62000	54000	-
24	92000	92000	92000	83800	70000	-
30×24	36000	36000	36000	32900	-	-
26	110000	110000	110000	98500	-	-
28	121000	121000	121000	113000	-	-
30	145000	144000	144000	130000	-	-
36×30	64000	64000	64000	61500	-	-
32	170000	170000	170000	151000	-	-
36×32	87000	87000	87000	69500	-	-
36	210000	210000	210000	198200	-	-
40	267500	267500	267500	-	-	-
42×36	96700	96700	96700	-	-	-
42	280000	280000	280000	-	-	-
48	384000	384000	384000	-	-	-
56×42	89000	89000	89000	-	-	-
56	521000	521000	521000	-	-	-

API 6A

NPS (inch)	CLASSES		
	3000	5000	10000
1 13/16	270	270	230
2 1/16	350	350	300
3 1/6	1000	940	890
4 1/16	1750	1700	1600
5 1/6	2900	2700	2450
7 1/16	5930	5400	5220

The Flow coefficient calculation

The flow coefficient CV of a valve is the flow rate of water (gallons/minutes) through a fully opened valve with a pressure drop of 1Psi across the valve, at 15.6 °C(60° F). The flow coefficient CV at the table show are come by test and confirmation.

Note: The relation of CV to Kv

$$Kv = Cv \times 0.85$$

For liquid medium

$$(1) Q_L = Cv \sqrt{\frac{\Delta P}{GL}}$$

$$(2) \Delta P = GL \left(\frac{Q_L}{Cv}\right)^2$$

At this: Q_L = Flow rate (U.S. Gal/min)
 ΔP = (P1-P2)pressure drop (Psi)
 GL = Liquid density (for water=1g/cm, at15.6 °C(60° F))

For gas medium

$$(3) Q_g = 1360 Cv \sqrt{\frac{\Delta P}{G_g T}} \cdot \sqrt{\frac{P_1 + P_2}{2}}$$

$$(4) \Delta P = P_1 \cdot \sqrt{P_1 \cdot 2G_g T \left(\frac{Q_g}{1360 Cv}\right)^2}$$

At this: Q_g = The volume flow rate of gas (SCFH)
 G_g = Gas density at standard condition
 Air density =1, at 15.6 °C(60° F)
 T = Absolute temperature of gas (° F+460)

Note: For gas, $\Delta P(\text{Max})=1/2 P_1$, $P_2(\text{Min})=1/2 P_1$,
 P_1 、 P_2 same as absolute pressure (psi)

Top Entry Floating Ball Valve

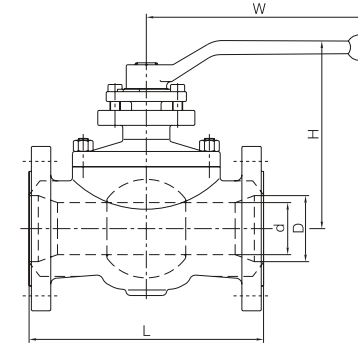

Top entry floating ball valve Dimensions & weight

Class		CLASS 150/300 Full bore					CLASS 400/600 Full bore				
NPS	d	L-RF	L-RTJ	L-WE	H	W	L-RF	L-RTJ	L-WE	H	W
1/2"	13	140	151	140	95	130	165	167	165	95	130
3/4"	19	152	165	152	110	150	190	190	190	115	150
1"	25	165	178	165	125	150	216	216	216	125	150
1 1/2"	38	191	203	191	150	200	241	241	241	155	200
2"	49	216	232	216	175	210	292	295	292	165	310

Class		CLASS 150/300 Reduced bore					CLASS 400/600 Reduced bore					
NPS	D	d	L-RF	L-RTJ	L-WE	H	W	L-RF	L-RTJ	L-WE	H	W
3/4"x1/2"	19	13	152	165	152	95	130	190	190	190	95	130
1"x3/4"	25	19	165	178	165	110	150	216	216	216	115	150
1 1/2"x1"	38	32	191	203	191	125	150	241	241	241	125	150
2"x1 1/2"	49	38	216	232	216	150	200	292	295	292	155	200
3"x2"	74	49	283	299	283	175	210	356	359	356	165	310

Floating Ball Valve

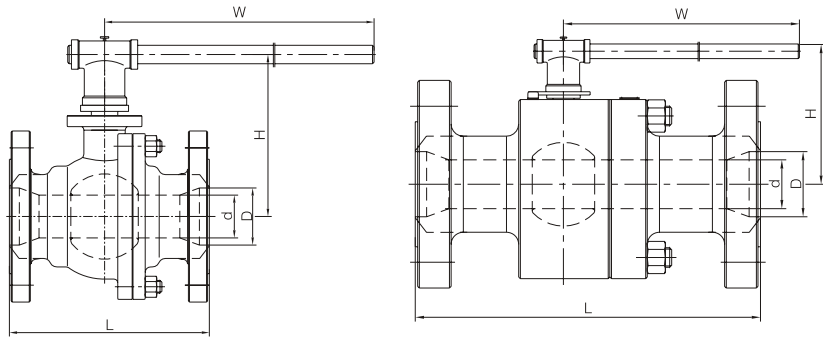

Split Body Floating Ball Valve dimensions & weights

Class		CLASS 150 full bore						CLASS 300 Full bore					
NPS	d	L-RF	L-RTJ	L-WE	H	W	Weight(Kg)	L-RF	L-RTJ	L-WE	H	W	Weight(Kg)
1/2"	13	108	108	140	81	150	2.8	140	151	140	81	150	3
3/4"	19	117	117	152	85	150	3.7	152	165	152	85	150	4
1"	25	127	140	165	98	180	5.3	165	178	165	98	180	6.6
1 1/2"	38	165	178	190	133	280	8.3	190	203	190	133	280	12.9
2"	49	178	191	216	141	280	15	216	232	216	141	280	21.4
2 1/2"	62	191	203	241	139	400	22.5	241	257	241	139	400	32.5
3"	74	203	216	283	150	400	27	283	298	283	150	400	45
4"	100	229	241	305	223	650	44.2	305	321	305	223	650	64.8
6"	150	394	406	457	297	*280	127.6	403	419	403	297	*300	147.5
8"	201	457	470	521	378	*280	221.8	502	518	521	378	*300	287.5
10"	252	533	546	559	408	*400	430	568	584	559	408	*400	550
12"	303	610	622	635	430	*400	680						

Class		CLASS 400 Full bore						CLASS 600 Full bore					
NPS	d	L-RF	L-RTJ	L-WE	H	W	Weight(Kg)	L-RF	L-RTJ	L-WE	H	W	Weight(Kg)
1/2"	13	165	167	165	66	150	3.5	165	167	165	66	150	3.5
3/4"	19	190	190	190	88	170	5	190	190	190	88	170	5
1"	25	216	216	216	90	250	7.5	216	216	216	90	250	7.5
1 1/2"	38	241	241	241	120	400	15	241	241	241	120	400	15
2"	49	292	295	292	135	400	29.4	292	295	292	135	400	29.4
2 1/2"	62	330	333	330	150	400	39.3	330	333	330	150	400	39.3
3"	74	356	359	356	164	400	58.2	356	359	356	164	400	58.2
4"	100	406	410	406	224	995	81.2	432	435	432	224	995	81.2

Floating Ball Valve

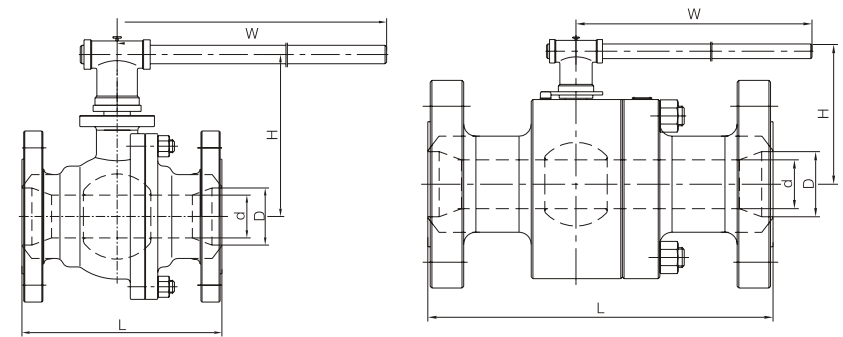

Split Body Floating Ball Valve dimensions & weights

Class		CLASS 900 Full bore						CLASS 1500 Full bore					
NPS	d	L-RF	L-RTJ	L-WE	H	W	Weight(Kg)	L-RF	L-RTJ	L-WE	H	W	Weight(Kg)
1/2"	13	216	216	216	75	140	5	216	216	216	75	140	5
3/4"	19	229	229	229	91	180	8	229	229	229	91	180	8
1"	25	254	254	254	108	250	10	254	254	254	108	250	10
1 1/2"	38	305	305	305	133	400	20	305	305	305	133	400	20
2"	49	368	371	368	150	500	30	368	371	368	150	500	30
2 1/2"	62	419	422	419	155	500	42	419	422	419	155	500	42
3"	74	381	384	381	160	500	55	368	371	368	160	500	65
4"	100												

Class		CLASS 2500 Full bore					
NPS	d	L-RF	L-RTJ	L-WE	H	W	Weight(Kg)
1/2"	13	264	264	264	88	230	7.5
3/4"	19	273	273	273	117	230	12
1"	25	308	308	308	128	300	15
1 1/2"	38	384	387	384	148	400	30
2"	42	451	454	451	183	500	37.5

Floating Ball Valve

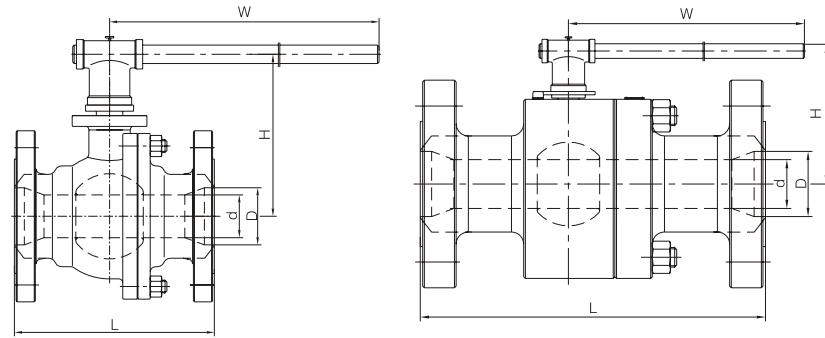

Floating Ball Valve

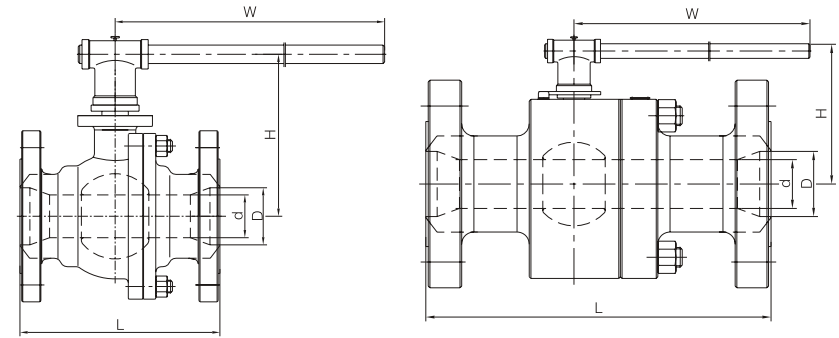

Split Body Floating Ball Valve dimensions & weights

Class		CLASS 150 Reduced bore							CLASS 300 Reduced bore						
NPS	D	d	L-RF	L-RTJ	L-WE	H	W	Weight(Kg)	L-RF	L-RTJ	L-WE	H	W	Weight(Kg)	
3/4"x1/2"	19	13	117	117	152	81	150	3.5	152	165	152	81	150	3.7	
1"x3/4"	25	19	127	140	165	85	150	5	165	178	165	85	150	5.8	
1 1/2"x1"	38	32	165	178	190	98	180	7.5	190	203	190	98	180	10.5	
2"x1 1/2"	49	38	178	191	216	133	280	10	216	232	216	133	280	16.1	
2 1/2"x2"	62	49	191	203	241	141	280	16	241	257	241	141	280	24.5	
3"x2"	74	49	203	216	283	141	280	21	283	298	283	141	280	34.7	
3"x2 1/2"	74	62	203	216	283	139	400	28	283	298	283	139	400	44	
4"x3"	100	74	229	241	305	150	400	35	305	321	305	150	400	53	
6"x4"	150	100	394	406	457	223	650	73	403	419	403	223	650	100	
8"x6"	201	150	457	470	521	297	*280	120	502	518	521	297	*300	170	
10"x8"	252	201	533	546	559	378	*280	200	502	518	521	378	*300	250	
12"x10"	303	252	610	622	635	408	*400	470	568	584	559	408	*400		
14"x12"	334	303	686	699	762	430	*400	500							

Split Body Floating Ball Valve dimensions & weights

Class		CLASS 900 Reduced bore							CLASS 1500 Reduced bore						
NPS	D	d	L-RF	L-RTJ	L-WE	H	W	Weight(Kg)	L-RF	L-RTJ	L-WE	H	W	Weight(Kg)	
3/4"x1/2"	19	13	229	229	229	75	140	7	229	229	229	75	140	7	
1"x3/4"	25	19	254	254	254	91	180	9.5	254	254	254	91	180	9.5	
1 1/2"x1"	38	32	305	305	305	108	250	16.5	305	305	305	108	250	16.5	
2"x1 1/2"	49	38	368	371	368	133	400	23	368	371	368	133	400	23	
2 1/2"x2"	62	49	419	422	419	150	500	32	419	422	419	150	500	42	
3"x2"	74	49	381	384	381	150	500	42	368	371	368	150	500	60	
3"x2 1/2"	74	62	381	384	381	155	500	53	368	371	368	155	500	65	
4"x3"	100	74	457	460	457	160	500	65	470	473	470	160	500	78	
6"x4"	150	100													

Class		CLASS 400 Reduced bore							CLASS 600 Reduced bore						
NPS	D	d	L-RF	L-RTJ	L-WE	H	W	Weight(Kg)	L-RF	L-RTJ	L-WE	H	W	Weight(Kg)	
3/4"x1/2"	19	13	190	190	190	66	150	4	165	167	165	66	150	4	
1"x3/4"	25	19	216	216	216	88	170	5.5	190	190	190	88	170	5.5	
1 1/2"x1"	38	32	241	241	241	90	250	10.5	216	216	216	90	250	10.5	
2"x1 1/2"	49	38	292	295	292	120	400	20	241	241	241	120	400	20	
2 1/2"x2"	62	49	330	333	330	135	400	25	330	333	330	135	400	25	
3"x2"	74	49	356	359	356	135	400	29	356	359	356	135	400	29	
3"x2 1/2"	74	62	356	359	356	150	400	42	356	359	356	150	400	42	
4"x3"	100	74	406	410	406	164	400	59	432	435	432	164	400	59	
6"x4"	150	100	495	498	495	224	995	95	432	435	432	224	995	95	

Class		CLASS 2500 Reduced bore						
NPS	D	d	L-RF	L-RTJ	L-WE	H	W	Weight(Kg)
3/4"x1/2"	19	13	273	273	273	88	230	11
1"x3/4"	25	19	308	308	308	117	230	14
1 1/2"x1"	38	25	384	387	384	128	300	25
2"x1 1/2"	42	38	451	454	451	148	400	35
3"x2"	62	52	578	584	578	183	500	60

Trunnion Mounted Ball Valve

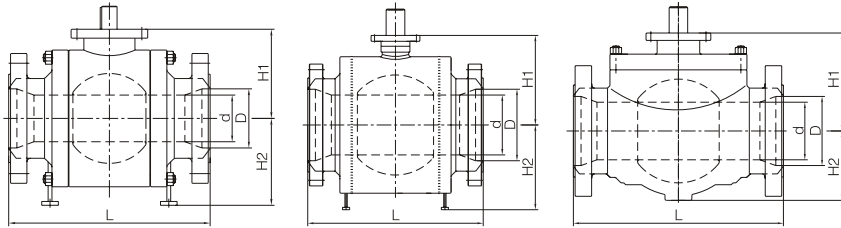

Dimensions & weights

ASME Class 150 Full bore

Valve type		Side entry						Fully welded						Top entry					
NPS	D	L-RF	L-RTJ	LWE	H1	H2	Weight (Kg)	L-RF	L-RTJ	LWE	H1	H2	Weight (Kg)	L-RF	L-RTJ	LWE	H1	H2	Weight (Kg)
2"	49	178	191	216	106	102	16	178	191	216	106	102	14.5	292	295	292	207	85	30
2 1/2"	62	191	203	241	155	105	20	191	203	241	155	105	18	330	330	330	211	95	40
3"	74	203	216	283	157	111	39	203	216	283	157	111	35.5	356	359	356	223	114	57
4"	100	229	241	305	198	187	55	229	241	305	198	187	50	432	435	432	280	140	100
6"	150	394	406	457	242	235	169	394	406	457	242	235	135	559	562	559	275	219	215
8"	201	457	470	521	288	280	244	457	470	521	288	280	283	660	664	660	321	265	407
10"	252	533	546	559	323	320	439	533	546	559	323	320	430	787	791	787	355	315	560
12"	303	610	622	635	375	355	688	610	622	635	375	355	558	838	841	838	470	405	710
14"	334	686	699	762	430	400	896	686	699	762	430	400	793	889	892	889	455	432	760
16"	385	762	775	838	448	470	1215	762	775	838	448	470	1134	991	994	991	460	451	1100
18"	436	864	876	914	477	510	1625	864	876	914	477	510	1468	1092	1095	1092	503	472	1512
20"	487	914	927	991	520	550	1850	914	927	991	520	550	1946	1194	1200	1194	560	560	1930
22"	538	991	1003	1092	528	477	2359	991	1003	1092	528	477	2123	1295	1305	1295	565	591	2750
24"	589	1067	1080	1143	640	640	3120	1067	1080	1143	640	640	3200	1397	1407	1397	610	600	3200
26"	633	1143	1270	1245	675	700	4120	1143	1270	1245	675	700	3813	1448	1461	1448	670	632	3800
28"	684	1245	1376	1346	728	720	5200	1245	1376	1346	728	720	4505	1549	1562	1549	730	710	4600
30"	735	1295	1423	1397	749	780	5946	1295	1423	1397	749	780	4707	1651	1664	1651	800	790	5630
32"	779	1372	1555	1524	803	760	7020	1372	1555	1524	803	760	6287	1778	1794	1778	846	830	7085
34"	830	1473	1655	1626	850	900	7800	1473	1655	1626	850	900	7020	1930	1946	1930	870	880	7800
36"	874	1524	1758	1727	895	930	10300	1524	1758	1727	895	930	9450	2083	2099	2083	935	933	9100
40"	976	1753		1780	965	948	13350	1753		1780	965	948	11450	2337	2337	2337	1012	1030	12790
42"	1020	1790		1840	965	948	14280	1790		1840	965	948	12852	2437	2437	2437	1070	1065	15100
48"	1166	1995		2100	1097	1066	24210	1995		2100	1097	1066	24000	2540	2540	2540	1190	1230	22600
56"	1360	2300		2250	1302	1253	34100	2300		2250	1302	1253	30690						
60"	1458	2489		2489	1418	1380	38500	2489		2489	1418	1380	42300						

Trunnion Mounted Ball Valve

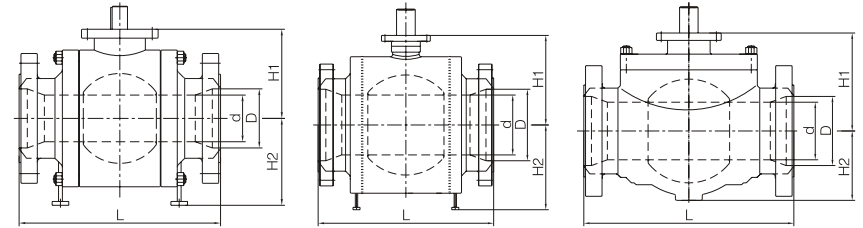

Dimensions & weights

ASME Class 150 Reduced bore

Valve type		Side entry						Fully welded						Top entry						
NPS	D	d	L-RF	L-RTJ	LWE	H1	H2	Weight (Kg)	L-RF	L-RTJ	LWE	H1	H2	Weight (Kg)	L-RF	L-RTJ	LWE	H1	H2	Weight (Kg)
2"x1 1/2"	49	38	178	191	216	106	102	16	178	191	216	106	102	14.5	292	295	292	207	85	25
2 1/2"x2"	62	49	191	203	241	106	102	20	191	203	241	106	102	18	330	330	330	210	87	32
3"x2"	74	49	203	216	283	106	102	21	203	216	283	106	102	19	356	359	356	210	87	34
3"x2 1/2"	74	62	203	216	283	130	110	22	203	216	283	130	110	20	356	359	356	215	95	50
4"x3"	100	74	229	241	305	157	111	45	229	241	305	157	111	41	432	435	432	225	110	70
6"x4"	150	100	394	406	457	198	187	68	394	406	457	198	187	61.5	559	562	559	270	143	130
8"x6"	201	150	457	470	521	242	235	186	457	470	521	242	235	151	660	664	660	275	215	250
10"x8"	252	201	533	546	559	288	280	266	533	546	559	288	280	294	787	791	787	320	262	455
12"x10"	303	252	610	622	635	323	320	478	610	622	635	323	320	440	838	841	838	355	310	485
14"x10"	334	252	686	699	762	323	320	507	686	699	762	323	320	513	889	892	889	355	310	665
14"x12"	334	303	686	699	762	375	355	724	686	699	762	375	355	588	889	892	889	475	395	790
16"x12"	385	303	762	775	838	375	355	767	762	775	838	375	355	643	991	994	991	475	395	940
16"x14"	385	334	762	775	838	430	400	935	762	775	838	430	400	838	991	994	991	450	430	908
18"x16"	436	385	864	876	914	448	470	1265	864	876	914	448	470	1162	1092	1095	1092	460	450	1248
20"x16"	487	385	914	927	991	448	470	1310	914	927	991	448	470	1235	1194	1200	1194	460	450	1542
20"x18"	487	436	914	927	991	477	510	1670	914	927	991	477	510	1521	1194	1200	1194	495	470	1740
24"x20"	589	487	1067	1080	1143	520	550	1970	1067	1080	1143	520	550	2120	1397	1407	1397	550	580	2378
30"x24"	735	589	1295	1423	1397	640	640	3420	1295	1423	1397	640	640	3695	1651	1664	1651	590	592	4008
36"x30"	874	735	1524	1758	1727	749	780	6376	1524	1758	1727	749	780	5554	2083	2099	2083	795	765	7048
40"x36"	976	874	1753		1780	895	930	10700	1753		1780	895	930	9622						

Trunnion Mounted Ball Valve

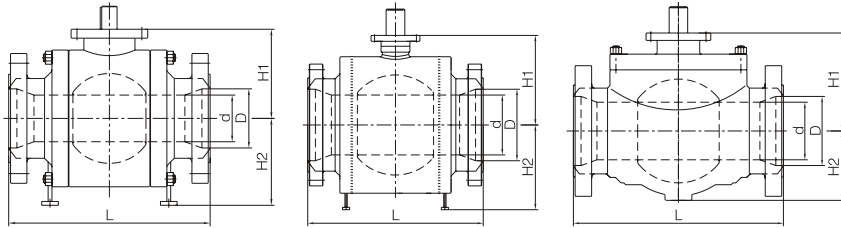

Dimensions & weights

ASME Class 300 Full bore

Valve type	Side entry							Fully welded					Top entry						
	NPS	D	L-RF	L-RTJ	LWE	H1	H2	Weight (Kg)	L-RF	L-RTJ	LWE	H1	H2	Weight (Kg)	L-RF	L-RTJ	LWE	H1	H2
2"	49	216	232	216	100	85	21	216	232	216	100	85	19	292	295	292	211	90	36
2 1/2"	62	241	257	241	125	100	25	241	257	241	125	100	22.5	330	330	330	218	105	50
3"	74	283	298	283	158	121	50	283	298	283	158	121	45	356	359	356	226	119	63
4"	100	305	321	305	191	142	87	305	321	305	191	142	78.5	432	435	432	286	145	106
6"	150	403	419	403	242	235	192	403	419	403	242	235	140	559	562	559	282	224	221
8"	201	502	518	521	288	280	333	502	518	521	288	280	308	660	664	660	325	270	412
10"	252	568	584	559	337	320	559	568	584	559	337	320	469	787	791	787	360	320	566
12"	303	648	664	635	375	355	728	648	664	635	375	355	590	838	841	838	475	410	715
14"	334	762	778	762	407	400	985	762	778	762	407	400	845	889	892	889	460	437	766
16"	385	838	854	838	473	460	1390	838	854	838	473	460	1180	991	994	991	465	456	1106
18"	436	914	930	914	485	510	1810	914	930	914	485	510	1600	1092	1095	1092	508	477	1519
20"	487	991	1010	991	540	555	2350	991	1010	991	540	555	2112	1194	1200	1194	565	565	1936
22"	538	1092	1114	1092	560	575	2788	1092	1114	1092	560	575	2509	1295	1305	1295	572	596	2756
24"	589	1143	1165	1143	673	635	3715	1143	1165	1143	673	635	3300	1397	1407	1397	617	605	3208
26"	633	1245	1270	1245	677	700	4780	1245	1270	1245	677	700	4296	1448	1461	1448	678	637	3808
28"	684	1346	1372	1346	762	720	5600	1346	1372	1346	762	720	4920	1549	1562	1549	738	715	4607
30"	735	1397	1422	1397	772	800	6530	1397	1422	1397	772	800	5940	1651	1664	1651	811	795	5638
32"	779	1524	1553	1524	815	848	7820	1524	1553	1524	815	848	7050	1778	1794	1778	850	835	7092
34"	830	1626	1654	1626	820	8860	9040	1626	1654	1626	820	8860	8136	1930	1946	1930	877	885	7811
36"	874	1727	1756	1727	918	950	12010	1727	1756	1727	918	950	10205	2083	2099	2083	942	938	9112
40"	976	1850		1780	987	980	15000	1850		1780	987	980	12546	2337	2337	2337	1020	1036	12798
42"	1020	1900		1840	1012	1020	16105	1900		1840	1012	1020	17550	2437	2437	2437	1081	1070	15113
48"	1166	2180		2100	1208	1200	25300	2180		2100	1208	1200	22540	2540	2540	2540	1201	1236	22614
56"	1360	2300		2250	1285	1270	38155	2300		2250	1285	1270	34340						
60"	1458	2743		2743	1380	1440	46600	2743		2743	1380	1440	44910						

Trunnion Mounted Ball Valve

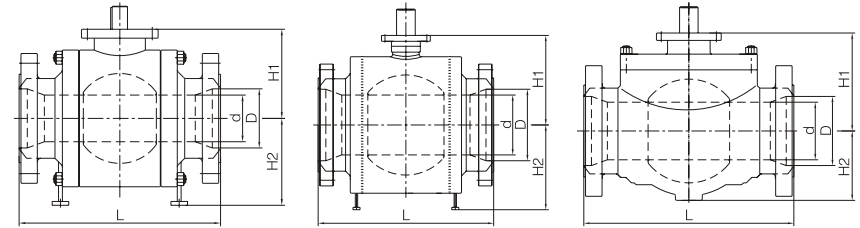

Dimensions & weights

ASME Class 300 Reduced bore

Valve type	Side entry							Fully welded					Top entry							
	NPS	D	d	L-RF	L-RTJ	LWE	H1	H2	Weight (Kg)	L-RF	L-RTJ	LWE	H1	H2	Weight (Kg)	L-RF	L-RTJ	LWE	H1	H2
2"x1 1/2"	49	38	216	232	216	100	85	20	216	232	216	100	85	18	292	295	292	206	80	26
2 1/2"x2"	62	49	241	257	241	100	85	26	241	257	241	100	85	23.5	330	330	330	211	90	40
3"x2"	74	49	283	298	283	125	100	28	283	298	283	125	100	25	356	359	356	211	90	42
3"x2 1/2"	74	62	283	298	283	125	100	30.5	283	298	283	125	100	27.5	356	359	356	218	105	60
4"x3"	100	74	305	321	305	158	121	58	305	321	305	158	121	53	432	435	432	226	119	82
6"x4"	150	100	403	419	403	191	142	106	403	419	403	191	142	96	559	562	559	286	145	161
8"x6"	201	150	502	518	521	242	235	218	502	518	521	242	235	170	660	664	660	282	224	285
10"x8"	252	201	568	584	559	288	280	370	568	584	559	288	280	322	787	791	787	325	270	536
12"x10"	303	252	648	664	635	337	320	610	648	664	635	337	320	485	838	841	838	360	320	572
14"x10"	334	252	762	778	762	337	320	685	762	778	762	337	320	552	889	892	889	360	320	781
14"x12"	334	303	762	778	762	375	355	807	762	778	762	375	355	620	889	892	889	475	410	916
16"x12"	385	303	838	854	838	375	355	862	838	854	838	375	355	672	991	994	991	475	410	1092
16"x14"	385	334	838	854	838	407	400	1045	838	854	838	407	400	890	991	994	991	460	437	1095
18"x16"	436	385	914	930	914	473	460	1460	914	930	914	473	460	1208	1092	1095	1092	465	456	1462
20"x16"	487	385	991	1010	991	473	460	1545	991	1010	991	473	460	1292	1194	1200	1194	465	456	1809
20"x18"	487	436	991	1010	991	485	510	1900	991	1010	991	485	510	1657	1194	1200	1194	508	477	2023
24"x20"	589	487	1143	1165	1143	540	555	2550	1143	1165	1143	540	555	2335	1397	1407	1397	565	565	2774
30"x24"	735	589	1397	1422	1397	673	635	4210	1397	1422	1397	673	635	3900	1651	1664	1651	617	605	4665
36"x30"	874	735	1727	1756	1727	772	800	7250	1727		1727	772	800	6948	2083	2099	2083	811	795	8298
40"x36"	976	874	1850		1780	918	950	12000	1850		1780	918	950	10376						

Trunnion Mounted Ball Valve

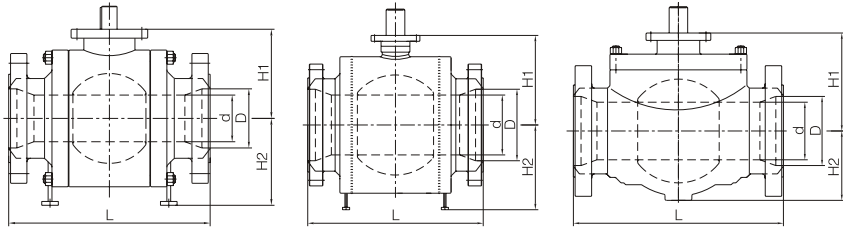

Dimensions & weights

ASME Class 400 Full bore

Valve type	Side entry							Fully welded					Top entry						
	NPS	D	L-RF	L-RTJ	LWE	H1	H2	Weight (Kg)	L-RF	L-RTJ	LWE	H1	H2	Weight (Kg)	L-RF	L-RTJ	LWE	H1	H2
2"	49	292	295	292	102	98	36	292	295	292	12	98	32.5	292	295	292	240	85	41
2 1/2"	62	330	333	330	130	110	51	330	333	330	130	110	46	330	330	330	270	95	52
3"	74	356	359	356	165	128	72	356	359	356	165	128	65	356	359	356	305	116	67
4"	100	406	410	406	210	160	102	406	410	406	210	160	92	432	435	432	275	140	230
6"	150	495	498	495	242	235	230	495	498	495	242	235	180	559	562	559	296	180	420
8"	201	597	600	597	289	280	420	597	600	597	289	280	322	660	664	660	324	275	417
10"	252	673	676	673	337	320	630	673	676	673	337	320	496	787	791	787	365	325	570
12"	303	762	765	762	379	365	902	762	765	762	379	365	687	838	841	838	480	415	720
14"	334	826	829	826	398	395	1121	826	829	826	398	395	890	889	892	889	465	442	770
16"	385	902	905	902	453	470	1612	902	905	902	453	470	1345	991	994	991	470	461	1112
18"	436	978	981	978	500	510	2010	978	981	978	500	510	1678	1092	1095	1092	512	482	1523
20"	487	1054	1060	1054	540	560	2446	1054	1060	1054	540	560	2291	1194	1200	1194	570	570	1940
22"	538	1143	1153	1143	625	593	3787	1143	1153	1143	625	593	3411	1295	1305	1295	578	602	2760
24"	589	1232	1241	1232	641	660	4095	1232	1241	1232	641	660	3792	1397	1407	1397	622	610	3213
26"	633	1308	1321	1308	681	700	5020	1308	1321	1308	681	700	4500	1448	1461	1448	682	640	3813
28"	684	1397	1410	1397	738	760	6200	1397	1410	1397	738	760	5170	1549	1562	1549	742	722	4612
30"	735	1524	1537	1524	781	800	7370	1524	1537	1524	781	800	7542	1651	1664	1651	817	804	5640
32"	779	1651	1667	1651	819	850	9890	1651	1667	1651	819	850	8008	1778	1794	1778	855	840	7103
34"	830	1778	1794	1778	840	850	11336	1778	1794	1778	840	850	10202	1930	1946	1930	893	890	7822
36"	874	1880	1895	1880	920	880	13250	1880	1895	1880	920	880	11005	2083	2099	2083	947	944	9118
40"	976	2000		1900	987	980	18335	2000		1900	987	980	13540	2337	2337	2337	1025	1041	12805
42"	1020	2100		1950	1012	1020	21356	2100		1950	1012	1020	19220	2437	2437	2437	1086	1075	15118
48"	1166	2400		2180	1208	1200	31195	2400		2180	1208	1200	24000	2540	2540	2540	1506	1240	22619
56"	1360	2710		2385	1290	1450	47483	2710		2385	1290	1450	42735						
60"	1458	2949		2949	1510	1550	61500	2949		2949	1510	1550	47700						

Trunnion Mounted Ball Valve

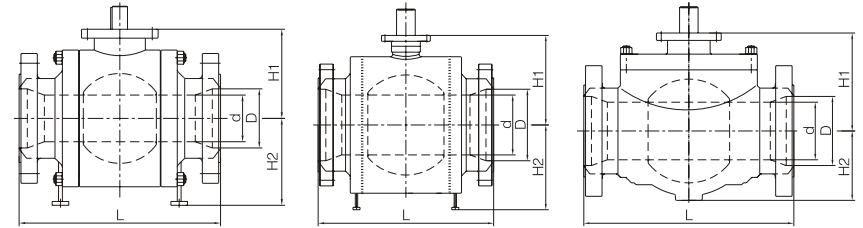

Dimensions & weights

ASME Class 400 Reduced bore

Valve type	Side entry							Fully welded					Top entry							
	NPS	D	d	L-RF	L-RTJ	LWE	H1	H2	Weight (Kg)	L-RF	L-RTJ	LWE	H1	H2	Weight (Kg)	L-RF	L-RTJ	LWE	H1	H2
2"x1 1/2"	49	38	292	295	292	102	98	35	292	295	292	102	98	31.5	292	295	292	210	85	34
2 1/2"x2"	62	49	330	333	330	102	98	40	330	333	330	102	98	36	330	330	330	215	95	40
3"x2"	74	49	356	359	356	130	110	50	356	359	356	130	110	45	356	359	356	215	95	46
3"x2 1/2"	74	62	356	359	356	130	110	55	356	359	356	130	110	49.5	356	359	356	223	110	70
4"x3"	100	74	406	410	406	165	128	90	406	410	406	165	128	81	432	435	432	232	124	94
6"x4"	150	100	495	498	495	210	160	138	495	498	495	210	160	118	559	562	559	283	154	280
8"x6"	201	150	597	600	597	242	235	272	597	600	597	242	235	205	660	664	660	287	129	318
10"x8"	252	201	673	676	673	289	280	495	673	676	673	289	280	346	787	791	787	324	275	600
12"x10"	303	252	762	765	762	337	320	678	762	765	762	337	320	511	838	841	838	365	325	719
14"x10"	334	252	826	829	826	337	320	795	826	829	826	337	320	562	889	892	889	365	325	991
14"x12"	334	303	826	829	826	379	365	1025	826	829	826	379	365	705	889	892	889	480	415	1191
16"x12"	385	303	902	905	902	379	365	1160	902	905	902	379	365	751	991	994	991	480	415	1411
16"x14"	385	334	902	905	902	398	395	1260	902	905	902	398	395	937	991	994	991	465	442	1377
18"x16"	436	385	978	981	978	453	470	1705	978	981	978	453	470	1375	1092	1095	1092	470	461	1856
20"x16"	487	385	1054	1060	1054	453	470	1852	1054	1060	1054	453	470	1455	1194	1200	1194	470	461	2896
20"x18"	487	436	1054	1060	1054	500	510	2165	1054	1060	1054	500	510	1740	1194	1200	1194	512	482	2930
24"x20"	589	487	1232	1241	1232	540	560	2785	1232	1241	1232	540	560	2552	1397	1407	1397	570	570	3518
30"x24"	735	589	1524	1537	1524	641	660	4660	1524	1537	1524	641	660	4480	1651	1664	1651	622	610	5968
36"x30"	874	735	1880	1895	1880	781	800	8150	1880		1880	781	800	8673	2083	2099	2083	817	804	10572
40"x36"	976	874	2000		1900	920	880	13260	2000		1900	920	880	11070						

Trunnion Mounted Ball Valve

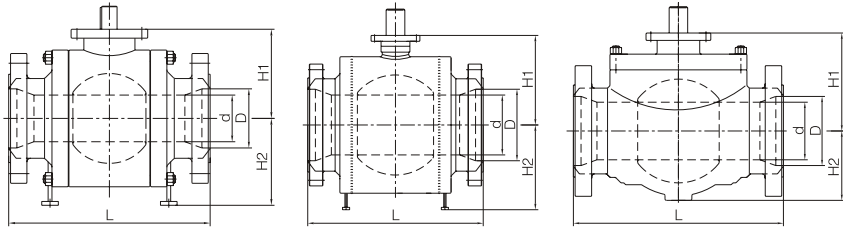

Dimensions & weights

ASME Class 600 Full bore

Valve type	Side entry						Fully welded						Top entry							
	NPS	D	L-RF	L-RTJ	LWE	H1	H2	Weight (Kg)	L-RF	L-RTJ	LWE	H1	H2	Weight (Kg)	L-RF	L-RTJ	LWE	H1	H2	Weight (Kg)
2"	49	292	295	292	102	98	36	292	295	292	102	98	32.5	292	295	292	240	85	41	
2 1/2"	62	330	333	330	130	110	51	330	333	330	130	110	46	330	330	330	270	95	52	
3"	74	356	359	356	165	128	72	356	359	356	165	128	65	356	359	356	305	116	67	
4"	100	432	435	432	210	160	123	432	435	432	210	160	92	432	435	432	275	140	230	
6"	150	559	562	559	248	235	290	559	562	559	248	235	210	559	562	559	296	180	420	
8"	201	660	664	660	297	280	456	660	664	660	297	280	332	660	664	660	324	275	417	
10"	252	787	791	787	337	320	777	787	791	787	337	320	549	787	791	787	365	325	570	
12"	303	838	841	838	379	365	1029	838	841	838	379	365	750	838	841	838	480	415	720	
14"	334	889	892	889	398	400	1295	889	892	889	398	400	950	889	892	889	465	442	770	
16"	385	991	994	991	447	458	1732	991	994	991	447	458	1510	991	994	991	470	461	1112	
18"	436	1092	1095	1092	541	510	2400	1092	1095	1092	541	510	1860	1092	1095	1092	512	482	1523	
20"	487	1194	1200	1194	289	560	2820	1194	1200	1194	289	560	2465	1194	1200	1194	570	570	1940	
22"	538	1295	1305	1295	642	600	3787	1295	1305	1295	642	600	3411	1295	1305	1295	578	602	2760	
24"	589	1397	1407	1397	692	645	4770	1397	1407	1397	692	645	4220	1397	1407	1397	622	610	3213	
26"	633	1448	1461	1448	730	690	5785	1448	1461	1448	730	690	4850	1448	1461	1448	682	640	3813	
28"	684	1549	1562	1549	794	790	6900	1549	1562	1549	794	790	5560	1549	1562	1549	742	722	4612	
30"	735	1651	1664	1651	789	820	8355	1651	1664	1651	789	820	7542	1651	1664	1651	817	804	5640	
32"	779	1778	1794	1778	833	860	9890	1778	1794	1778	833	860	8480	1778	1794	1778	855	840	7103	
34"	830	1930	1946	1930	850	860	11336	1930	1946	1930	850	860	10202	1930	1946	1930	893	890	7822	
36"	874	2083	2099	2083	920	880	16170	2083	2099	2083	920	880	11910	2083	2099	2083	947	944	9118	
40"	976	2000		1900	987	980	18335	2000		1900	987	980	14000	2169	2169	2169	1025	1041	12805	
42"	1020	2100		1950	1012	1020	21356	2100		1950	1012	1020	19220	2437	2437	2437	1086	1075	15118	
48"	1166	2400		2180	1208	1200	31195	2400		2180	1208	1200	24000	2435	2435	2435	1506	1240	22619	
56"	1360	2710		2385	1290	1450	47483	2710		2385	1290	1450	42735							
60"	1458	2949		2949	1510	1550	61500	2949		2949	1510	1550	47700							

Trunnion Mounted Ball Valve

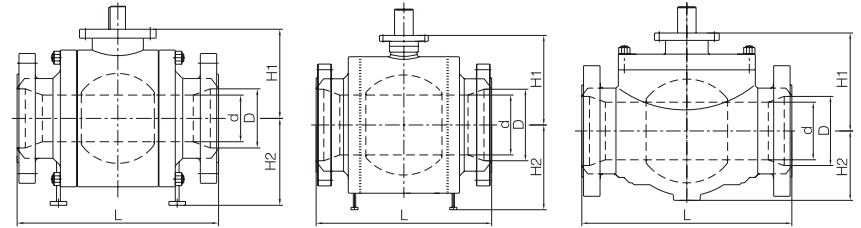

Dimensions & weights

ASME Class 600 Reduced bore

Valve type	Side entry						Fully welded						Top entry								
	NPS	D	d	L-RF	L-RTJ	LWE	H1	H2	Weight (Kg)	L-RF	L-RTJ	LWE	H1	H2	Weight (Kg)	L-RF	L-RTJ	LWE	H1	H2	Weight (Kg)
2"x1 1/2"	49	38	292	295	292	102	98	35	292	295	292	102	98	31.5	292	295	292	210	85	34	
2 1/2"x2"	62	49	330	333	330	102	98	40	330	333	330	102	98	36	330	330	330	215	95	40	
3"x2"	74	49	356	359	356	130	110	50	356	359	356	130	110	45	356	359	356	215	95	46	
3"x2 1/2"	74	62	356	359	356	130	110	55	356	359	356	130	110	49.5	356	359	356	223	110	70	
4"x3"	100	74	432	435	432	165	128	90	432	435	432	165	128	81	432	435	432	232	124	94	
6"x4"	150	100	559	562	559	210	160	160	559	562	559	210	160	124	559	562	559	283	154	280	
8"x6"	201	150	660	664	660	248	235	332	660	664	660	248	235	235	660	664	660	287	129	318	
10"x8"	252	201	787	791	787	297	280	540	787	791	787	297	280	377	787	791	787	324	275	600	
12"x10"	303	252	838	841	838	337	320	825	838	841	838	337	320	560	838	841	838	365	325	719	
14"x10"	334	252	889	892	889	337	320	942	889	892	889	337	320	595	889	892	889	365	325	991	
14"x12"	334	303	889	892	889	379	365	1152	889	892	889	379	365	765	889	892	889	480	415	1191	
16"x12"	385	303	991	994	991	379	365	1288	991	994	991	379	365	820	991	994	991	480	415	1411	
16"x14"	385	334	991	994	991	398	400	1442	991	994	991	398	400	1018	991	994	991	465	442	1377	
18"x16"	436	385	1092	1095	1092	447	458	1838	1092	1095	1092	447	458	1555	1092	1095	1092	470	461	1856	
20"x16"	487	385	1194	1200	1194	447	458	2000	1194	1200	1194	447	458	1686	1194	1200	1194	470	461	2896	
20"x18"	487	436	1194	1200	1194	541	510	2578	1194	1200	1194	541	510	1966	1194	1200	1194	512	482	2930	
24"x20"	589	487	1397	1407	1397	289	560	3215	1397	1407	1397	289	560	2798	1397	1407	1397	570	570	3518	
30"x24"	735	589	1651	1664	1651	692	645	5380	1651	1664	1651	692	645	4872	1651	1664	1651	622	610	5968	
36"x30"	874	735	2083	2099	2083	789	820	9375	2083		2083	789	820	8942	2083	2099	2083	817	804	10572	
40"x36"	976	874	2000		1900	920	880	15950	2000		1900	920	880	11320							

Trunnion Mounted Ball Valve

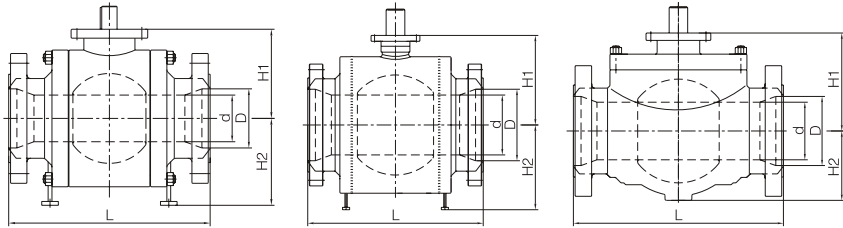

Dimensions & weights

ASME Class 900 Full bore

Valve type	Side entry						Fully welded						Top entry							
	NPS	D	L-RF	L-RTJ	LWE	H1	H2	Weight (Kg)	L-RF	L-RTJ	LWE	H1	H2	Weight (Kg)	L-RF	L-RTJ	LWE	H1	H2	Weight (Kg)
2"	49	368	371	368	104	103	70	368	371	368	104	103	45	368	371	368	295	110	52	
2 1/2"	62	419	422	419	130	115	102	419	422	419	130	115	55	419	422	419	260	115	80	
3"	74	381	384	381	163	132	105	381	384	381	163	132	68	381	384	381	230	122	110	
4"	100	457	460	457	211	169	183	457	460	457	211	169	135	457	460	457	283	154	200	
6"	150	610	613	610	259	213	372	610	613	610	259	213	234	610	613	610	329	203	430	
8"	201	737	740	737	297	264	719	737	740	737	297	264	440	737	740	737	375	245	800	
10"	252	838	841	838	342	333	1140	838	841	838	342	333	692	838	841	838	431	275	1000	
12"	303	965	968	965	384	379	1426	965	968	965	384	379	1035	965	968	965	511	322	1300	
14"	322	1029	1038	1029	398	368	1758	1029	1038	1029	398	368	1303	1029	1038	1029	520	443	1695	
16"	373	1130	1140	1130	436	137	2630	1130	1140	1130	436	137	1795	1130	1140	1130	582	390	2560	
18"	423	1219	1232	1219	484	497	3585	1219	1232	1219	484	497	2460	1219	1232	1219	580	487	3400	
20"	471	1321	1334	1321	532	503	5190	1321	1334	1321	532	503	3240	1321	1334	1321	625	605	4400	
22"	522	1435	1448	1435	575	565	5380	1435	1448	1435	575	565	4842	1435	1448	1435				
24"	570	1549	1568	1549	617	633	8515	1549	1568	1549	617	633	5088	1549	1568	1549	690	625	7200	
26"	617	1651	1674	1651	635	660	9200	1651	1674	1651	635	660	5906	1651	1674	1651				
28"	665	1753	1775	1753	674	706	11630	1753	1775	1753	674	706	7116	1753	1775	1753	820	723	10400	
30"	712	1880	1902	1880	723	777	13770	1880	1902	1880	723	777	10989	1880	1902	1880	880	800	12875	
32"	760	2032	2054	2032	784	809	16600	2032	2054	2032	784	809	10470	2032	2054	2032	938	870	15950	
34"	808	2159	2188	2159	807	852	17200	2159	2188	2159	807	852	15480	2159	2188	2159	982	920	17500	
36"	855	2286	2315	2286	848	898	23235	2286	2315	2286	848	898	12900	2286	2315	2286	1050	990	20600	
40"	956	2180	2210	2100	1160	1000	23260	2180	2210	2100	1160	1000	17930							
42"	1006	2250	2280	2180	1200	1080	27600	2250	2280	2180	1200	1080	21258							
48"	1149	2450	2480	2380	1262	1195	34800	2450	2480	2380	1262	1195	28000							
56"	1360	2949		2400	1416	1404	47483	2949		2400	1416	1404	42735							

Trunnion Mounted Ball Valve

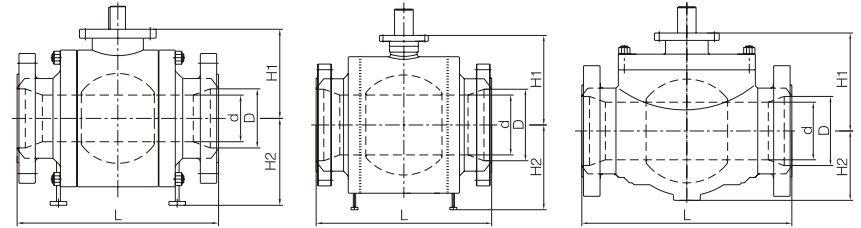

Dimensions & weights

ASME Class 900 Reduced bore

Valve type	Side entry						Fully welded						Top entry								
	NPS	D	d	L-RF	L-RTJ	LWE	H1	H2	Weight (Kg)	L-RF	L-RTJ	LWE	H1	H2	Weight (Kg)	L-RF	L-RTJ	LWE	H1	H2	Weight (Kg)
2"x1 1/2"	49	38	368	371	368	104	103	70	368	371	368	104	103	39	368	371	368	161	95	50	
2 1/2"x2"	62	49	419	422	419	104	103	81	419	422	419	104	103	47	419	422	419	211	84	75	
3"x2"	74	49	381	384	381	130	115	86	381	384	381	130	115	52	381	384	381	211	84	70	
3"x2 1/2"	74	62	381	384	381	130	115	96	381	384	381	130	115	55	381	384	381	220	110	105	
4"x3"	100	74	457	460	457	163	132	127	457	460	457	163	132	75	457	460	457	230	122	140	
6"x4"	150	100	610	613	610	211	169	243	610	613	610	211	169	165	610	613	610	283	154	273	
8"x6"	201	150	737	740	737	259	213	452	737	740	737	259	213	270	737	740	737	329	209	548	
10"x8"	252	201	838	841	838	297	264	802	838	841	838	297	264	480	838	841	838	375	245	906	
12"x10"	303	252	965	968	965	342	333	1258	965	968	965	342	333	725	965	968	965	431	275	1090	
14"x12"	322	303	1029	1038	1029	342	333	1440	1029	1038	1029	342	333	792	1029	1038	1029	380	324	1495	
16"x12"	373	303	1130	1140	1130	384	379	1758	1130	1140	1130	384	379	1128	1130	1140	1130	515	360	2100	
16"x14"	373	322	1130	1140	1130	398	368	1916	1130	1140	1130	398	368	1386	1130	1140	1130	520	360	2300	
18"x16"	423	373	1219	1232	1219	436	437	2885	1219	1232	1219	436	437	1850	1219	1232	1219	536	380	2837	
20"x16"	471	373	1321	1334	1321	436	437	3142	1321	1334	1321	436	437	2000	1321	1334	1321	582	390	3515	
20"x18"	471	423	1321	1334	1321	484	497	3856	1321	1334	1321	484	497	2581	1321	1334	1321	580	485	3875	
24"x20"	570	471	1549	1568	1549	532	503	6222	1549	1568	1549	532	503	3695	1549	1568	1549	629	604	5395	
30"x24"	712	570	1880	1902	1880	617	633	9522	1880	1902	1880	617	633	6072	1880	1902	1880	640	665	9000	
36"x30"	855	712	2286	2315	2286	723	777	15575	2286	2315	2286	723	777	12522	2286	2315	2286	777	795	15235	
40"x36"	956	855	2180	2210	2100	848	898	23505	2180	2210	2100	848	898	12200							

Trunnion Mounted Ball Valve

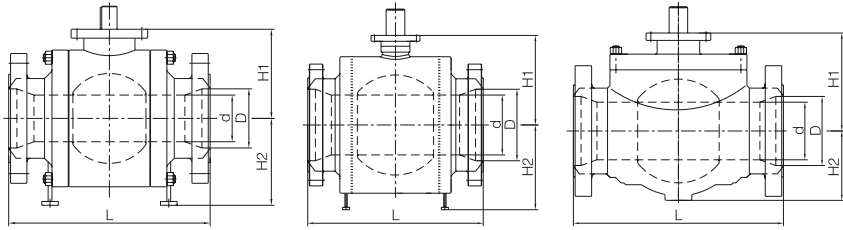

Dimensions & weights

ASME Class 1500 Full bore

Valve type		Side entry						Fully welded						Top entry					
NPS	D	L-RF	L-RTJ	L-WE	H1	H2	Weight (Kg)	L-RF	L-RTJ	L-WE	H1	H2	Weight (Kg)	L-RF	L-RTJ	L-WE	H1	H2	Weight (Kg)
2"	49	368	371	368	106	104	50	368	371	368	106	104	45	368	371	368	201	100	56
2 1/2"	62	419	422	419	130	115	72	419	422	419	130	115	67	419	422	419	215	110	100
3"	74	470	473	470	167	128	97	470	473	470	167	128	89	470	473	470	230	122	153
4"	100	546	549	546	179	170	198	546	549	546	179	170	179	546	549	546	293	164	278
6"	144	705	711	705	260	233	480	705	711	705	260	233	437	705	711	705	245	416	600
8"	192	832	841	832	304	290	820	832	841	832	304	290	745	832	841	832	465	273	1100
10"	239	991	1000	991	363	352	1500	991	1000	991	363	352	1357	991	1000	991	574	330	1438
12"	287	1130	1146	1130	417	425	2250	1130	1146	1130	417	425	2045	1130	1146	1130	520	427	2017
14"	315	1257	1276	1257	437	426	2850	1257	1276	1257	437	426	2565	1257	1276	1257	550	456	2612
16"	360	1384	1407	1384	475	493	4070	1384	1407	1384	475	493	3708	1384	1407	1384	565	487	3890
18"	406	1537	1559	1537	563	608	6195	1537	1559	1537	563	608	5634	1537	1559	1537	592	527	5100
20"	454	1664	1686	1664	617	645	9075	1664	1686	1664	617	645	7020	1664	1686	1664	650	630	6678
24"	546	1945	1972	1945	698	724	14280	1945	1972	1945	698	724	11120	1945	1972	1945	660	640	11700
28"	641	2032	2061	2032	941	1037	13100	2032	2061	2032	941	1037	11790						
30"	686	2286	2315	2286	1035	1066	14100	2286	2315	2286	1035	1066	12240						
32"	730	2415	2444	2415	1060	1165	15100	2415	2444	2415	1060	1165	13590						
36"	819	2743	2755	2743	1180	1306	18840	2743	2755	2743	1180	1306	16956						

Trunnion Mounted Ball Valve

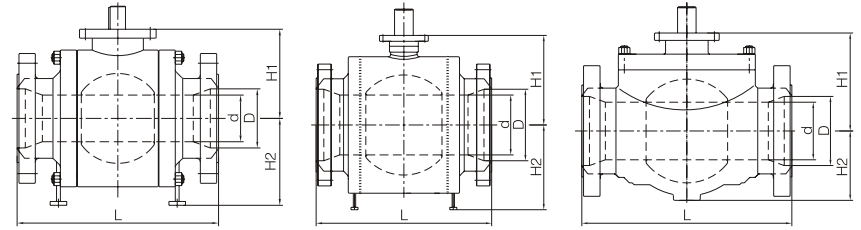

Dimensions & weights

ASME Class 1500 Reduced bore

Valve type		Side entry						Fully welded						Top entry						
NPS	D	d	L-RF	L-RTJ	L-WE	H1	H2	Weight (Kg)	L-RF	L-RTJ	L-WE	H1	H2	Weight (Kg)	L-RF	L-RTJ	L-WE	H1	H2	Weight (Kg)
2"x1 1/2"	49	38	368	371	368	104	103	41	368	371	368	104	103	41	368	371	368	161	95	50
2 1/2"x2"	62	49	419	422	419	104	103	50	419	422	419	104	103	44	419	422	419	211	105	98
3"x2"	74	49	470	473	470	130	115	68	470	473	470	130	115	48	470	473	470	211	105	110
3"x2 1/2"	74	62	470	473	470	130	115	95	470	473	470	130	115	65	470	473	470	220	110	150
4"x3"	100	74	546	549	546	167	128	122	546	549	546	167	128	88	546	549	546	229	121	203
6"x4"	144	100	705	711	705	179	170	285	705	711	705	179	170	266	705	711	705	293	164	376
8"x6"	192	144	832	841	832	260	233	566	832	841	832	260	233	437	832	841	832	416	245	703
10"x8"	239	192	991	1000	991	304	290	1022	991	1000	991	304	290	920	991	1000	991	465	273	1273
12"x10"	287	239	1130	1146	1130	363	352	1760	1130	1146	1130	363	352	1584	1130	1146	1130	574	330	1535
16"x12"	315	239	1257	1276	1257	363	352	2145	1257	1276	1257	363	352	1931	1257	1276	1257	580	330	2100
14"x12"	315	287	1257	1276	1257	417	425	2500	1257	1276	1257	417	425	2250	1257	1276	1257	580	427	2698
16"x12"	360	287	1384	1407	1384	417	425	2800	1384	1407	1384	417	425	2520	1384	1407	1384	630	427	3200
16"x14"	360	315	1384	1407	1384	437	426	3245	1384	1407	1384	437	426	2921	1384	1407	1384	640	455	3100
18"x16"	406	360	1537	1559	1537	475	493	4970	1537	1559	1537	475	493	4473	1537	1559	1537	657	493	4200
20"x16"	454	360	1664	1686	1664	475	493	5135	1664	1686	1664	475	493	4622	1664	1686	1664	657	493	4500
20"x18"	454	406	1664	1686	1664	563	608	7500	1664	1686	1664	563	608	6750	1664	1686	1664	693	527	5900
24"x20"	546	454	1945	1972	1945	617	645	10875	1945	1972	1945	617	645	9788	1945	1972	1945	757	620	9200

Trunnion Mounted Ball Valve

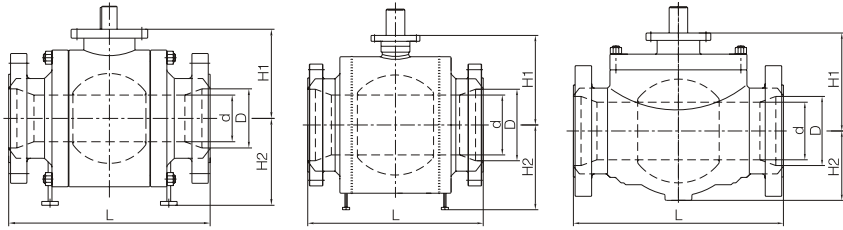

Dimensions & weights

ASME Class 2500 Full bore

Valve type		Side entry						Top entry					
NPS	D	L-RF	L-RTJ	L-WE	H1	H2	Weight (Kg)	L-RF	L-RTJ	L-WE	H1	H2	Weight (Kg)
2"	42	451	454	451	120	127	88	451	454	451	212	98	120
2 1/2"	52	508	540	508	150	162	135	508	540	508	225	110	180
3"	62	578	584	578	177	198	187	578	584	578	243	122	246
4"	87	673	683	673	227	233	380	673	683	673	299	164	470
6"	131	914	927	914	264	252	770	914	927	914	355	243	937
8"	179	1022	1038	1022	383	339	1357	1022	1038	1022	424	292	1410
10"	223	1270	1292	1270	453	422	2100	1270	1292	1270	503	352	2600
12"	265	1422	1445	1422	520	482	3210	1422	1445	1422	588	436	4200
14"	292	1681	1681	1681	578	558	5520						
16"	333	1962	1962	1962	650	620	6520						
18"	374	2134	2134	2134	810	740	8630						
20"	419	2286	2286	2286	900	825	11640						

Trunnion Mounted Ball Valve

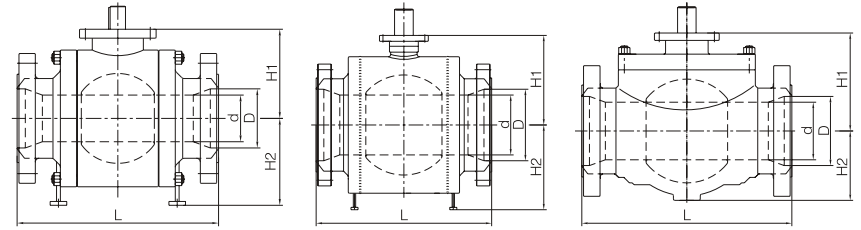

Dimensions & weights

ASME Class 2500 Reduced bore

Valve type		Side entry							Top entry					
NPS	D	d	L-RF	L-RTJ	L-WE	H1	H2	Weight (Kg)	L-RF	L-RTJ	L-WE	H1	H2	Weight (Kg)
2"x1 1/2"	42	38	451	454	451	120	82	65	451	454	451	212	98	80
2 1/2"x2"	52	42	508	540	508	127	88	105	508	540	508	212	98	160
3"x2"	62	42	578	584	578	162	135	155	578	584	578	212	98	190
3"x2 1/2"	62	52	578	584	578	162	135	210	578	584	578	220	100	230
4"x3"	87	62	673	683	673	198	187	264	673	683	673	243	122	300
6"x4"	131	87	914	927	914	233	380	510	914	927	914	299	164	670
8"x6"	179	131	1022	1038	1022	252	770	1090	1022	1038	1022	355	243	1150
10"x8"	223	179	1270	1292	1270	339	1357	1663	1270	1292	1270	424	292	2100
12"x10"	265	223	1422	1445	1422	422	2100	2555	1422	1445	1422	503	352	3300
16"x12"	333	265	1962	1962	1962	482	3210	5170						
18"x14"	374	292	2134	2134	2134	558	5520	6670						
20"x16"	419	333	2286	2286	2286	620	6520	8955						